

Broadweigh® User Manual



mantracourt.com



BROAD WEIGH

Load monitoring for live events
Solved by Mantracourt®

Introduction / Overview	9
Navigating This Manual	9
Safe Use	9
Inspection and Maintenance	13
Product Quick Locator	14
Broadweigh Basic Principles	15
Transmitters & Receivers	15
Transmitters.....	15
Receivers	15
Radio Channel and Group Key.....	15
Radio Channel	15
Group Key.....	15
Configuring Multiple Modules to Use the Same Radio Settings.....	16
ID and Data Tags	16
Transmitter Module Modes of Operation	16
Normal	16
Configuration	16
Sleep.....	16
Smart Sleep.....	16
Transmitter Module Sleep Delay Settings	17
Pairing	17
Pairing From Broadweigh Toolkit	18
Pairing From a Receiver Module.....	18
Soft Pairing	18
Configuring an Attached Base Station.....	18
Asynchronous Operation and Logging.....	18
Bandwidth.....	19
Repeaters and Repeater Subgroups	19
Broadweigh Toolkit	20
Common Toolkit Pages	21
Setup Base Station Communications	21
Spectrum Analyser.....	22
Planar View Parts	23
Examples	24
Channel Monitor.....	26
Home.....	29
Connecting to a remote module	29
Connecting to the attached base station module.....	29
Manual Connection	30
Information.....	31
Battery and Radio Levels.....	32
Battery and Radio Levels Advanced	33
Radio Settings	34
Radio Settings Advanced.....	35
Save and Restore	36
Transmitter Modules	37
BW-S325, BW-S475, BW-S475-TL, BW-TL, BW-S900	37
Overview	37
Order Codes	38
BW-S325	38
BW-S475	38
BW-TL (Optional Part)	38
BW-S475-TL.....	38
BW-S900	38
Orientation & Identification	39

Connections.....	40
Connecting Power	40
Configuration	41
Simple Configuration Mode	42
Settings	42
Managed Parameters	43
Parameters Pre-configured.....	43
Parameters Hidden From View	43
Advanced Configuration Mode.....	44
Units	44
Zero Settings	45
Data Rates and Quality	45
Advanced Settings	48
Smart Sleep.....	49
Enclosure & Mounting	50
Dimensions	50
BW-S325	50
BW-S475	50
BW-S475-TL.....	51
BW-S900	51
BW-TL.....	52
Opening the Case	52
LED Indicator	52
Specification	53
Radio Range	53
BW-WSS.....	54
Overview	54
Order Codes	54
BW-WSS.....	54
Connections.....	55
Power.....	55
Configuration	56
Data Rates and Quality	56
Units	58
Advanced Settings	59
Enclosure & Mounting	60
Antennas.....	60
Specification	61
Radio Range	61
Receiver Modules	62
BW-HK-S.....	62
Overview	62
Order Code	62
BW-HK-S.....	62
Connections.....	62
Power.....	62
User Operation.....	63
Keypad	63
Display.....	64
Display Modes.....	64
List- Roaming	64
List-Defined	65
Detail	65
Radio	66
Icons	66

Configuration Using the Menu System.....	67
System.....	68
Display.....	68
User Interface	69
Time/Date	69
About.....	69
Actions	70
Actions Source	70
Action (warning, overload, underload and error)	70
Inputs Setup	71
Radio Channel and Group Key.....	71
Sleep/Wake.....	71
Inputs Info.....	71
Edit Inputs.....	71
Info.....	75
Action Cancel.....	75
Errors	75
Calibration	75
Inputs Info.....	75
System Info	75
About.....	75
Configuration Using the Toolkit	76
Home.....	76
Information.....	77
Settings	78
Interface	78
Key Actions	79
Clock.....	80
Import & Export	81
Export	81
Clone Export	82
Import.....	83
Standard Export File	84
Clone Export File	85
Configuration	86
Menus.....	86
Display Modes.....	87
Units.....	88
Custom Units.....	89
Pins	90
Firmware Upgrade	91
Management	92
Logging	95
Define Inputs.....	98
Roaming.....	100
Defined.....	101
Actions	104
Enclosure & Mounting	105
Antennas.....	105
Specification- BW-HK-S	105
Radio Range	105
BW-HR.....	106
Overview	106
Order Codes	106
BW-HR.....	106

Connections.....	107
Power.....	107
Operation.....	108
View readings.....	108
Keys.....	108
Indicators.....	108
Errors.....	109
Special Modes.....	109
Configuration.....	110
Display Format.....	110
Settings.....	112
Enclosure & Mounting.....	113
Antennas.....	113
Specification.....	114
Radio Range.....	114
BW-HA.....	115
Overview.....	115
Order Codes.....	115
BW-HA.....	115
Connections.....	115
Power.....	115
Quick Start.....	116
Connecting Power.....	116
BW-HA.....	116
Shackle or Transmitter Module.....	116
Viewing Shackle or Other Transmitter Data.....	116
Operation.....	117
Keys.....	117
Indicators.....	117
Errors.....	117
Configuration.....	119
Modes of Operation.....	119
No List Entered (Default).....	119
List Entered.....	119
List Entered Plus Summing Groups.....	119
Global Settings.....	120
Configure Inputs.....	122
No Defined Transmitters.....	122
Defined Transmitters.....	124
General Tab.....	124
Zero Tab.....	126
Scaling Tab.....	127
Group Membership Tab.....	128
Summing Groups.....	129
General Tab.....	129
Zero Tab.....	131
Scaling Tab.....	132
Members Tab.....	134
Example Configuration Scenarios.....	135
Examples Using No Defined Transmitter List (Roaming Mode).....	135
Festival Site.....	135
Tent Guy Wires.....	135
Example of Defined Transmitter List.....	135
Single Transmitter.....	135
Multiple Transmitters.....	135

Example of Summing Groups.....	135
Alternative Units.....	135
Grouping Sums	135
Enclosure & Mounting	138
Antennas.....	138
Specification	139
Radio Range	139
BW-RM1	140
Overview	140
Order Codes	140
BW-RM1.....	140
Connections.....	141
Power.....	141
Connections & Indicators	141
LEDs	141
Inputs.....	141
Operation.....	142
Configuration	143
Input Settings	143
Relay Settings	144
Operation and Hysteresis Settings	144
Relay Settings Advanced	145
Alarm Settings.....	146
Enclosure & Mounting	148
Antennas.....	148
Specification	149
Radio Range	149
BW-WM1	150
Overview	150
Order Codes	150
BW-WM1	150
Connections.....	151
Power.....	151
Connections & Indicators	151
LEDs.....	151
Inputs.....	151
Operation.....	152
Alarm	152
Configuration	153
Advanced Mode.....	153
Input Settings.....	153
Indicator Settings.....	154
Operation and Hysteresis Settings	155
Alarm Settings	155
Log100 Mode	157
Log100 Mode Settings.....	157
Additional Log100 Requirements	158
Enclosure & Mounting	159
Antennas.....	159
Specification	160
Radio Range	160
Base Stations & Repeater Modules	161
BW-BSue, BW-BSd, BW-BSi	161
Overview	161
Order Codes	161

BW-BSue	161
BW-BSd	161
BW-BSi.....	161
Addressing.....	161
Connections.....	162
BW-BSue & BW-BSd.....	162
BW-BSi.....	162
SW1 Settings	162
Address	162
Serial/USB	163
Power.....	163
LED Indication	163
RS232.....	164
RS485.....	164
Serial Limitations	164
USB	165
Configuration	166
Home	166
Radio Settings	167
Advanced Settings.....	168
Enclosure & Mounting	169
BW-BSue	169
BW-BSd	169
BW-BSi.....	169
Antennas.....	169
Specification	170
BW-BSi.....	170
BW-BSd	170
BW-BSue	170
Radio Range	170
BW-AR	171
Overview	171
Order Codes	171
BW-AR.....	171
Connections.....	172
Power.....	172
Power Options.....	172
Permanently Powered	172
Battery Powered.....	172
Getting Started.....	173
Increase Range	173
Span Obstacles.....	174
Combined Solutions	175
Considerations	176
Configuration	177
Settings	177
Enclosure & Mounting	178
Antennas.....	178
Radio Range	178
Specification	179
Radio Range	179
Gateways	180
SS-GT24B-A	180
Overview	180
Order Codes	181

SS-GT24B-A	181
Connections.....	182
Power.....	182
Digital Inputs	182
Digital Outputs.....	182
SW1 & SW2	183
LED Indication	184
Configuration	185
Status.....	185
Digital IO	187
Inputs (Broadweigh Transmitters)	189
Settings	191
Enclosure & Mounting	193
Antennas.....	193
Specification	194
Radio Range	194
Power Supply Modules.....	195
PP1 & SP1	195
Overview	195
Order Codes	195
PP1.....	195
SP1	195
Getting Started.....	196
Power Pack 1 Connections	196
Installation	196
Connecting Power Pack 1	196
Solar Panel Orientation	197
Operation.....	198
Dimensions & Weight.....	198
Specifications	199
Appendices.....	200
Appendix A – Enclosures	200
K Style (Handheld 2025)	200
Dimensions	200
Opening the case.....	200
Mounting information.....	200
Antenna position	201
Environmental protections	201
A Style (Handheld).....	202
Dimensions	202
Opening the Case	202
Mounting Information.....	203
Antenna Position.....	203
Environmental Protection	203
B Style (ACM).....	204
Dimensions	204
Opening the Case	204
Mounting Information.....	205
Optional Mounting Kit	205
Antenna Position.....	205
Environmental Protection	205
C Style (ACMi)	206
Dimensions	206
Opening the Case	206
Mounting Information.....	206

Antenna Position.....	206
Environmental Protection	206
H Style (Dongle).....	208
Dimensions	208
Opening the Case	208
Mounting Information.....	208
Antenna Position.....	208
Environmental Protection	208
Appendix B – Radio Range	209
Overview	209
Range	209
Appendix C - Radio Specification	210
Appendix D – Conditions of Use.....	211
Appendix E – Approval Statements.....	212
CE.....	212
IC.....	213
FCC.....	214
Appendix F - OEM / Reseller Marking and Documentation Requirements	215
CE.....	215
IC.....	216
FCC.....	217
Appendix G - Worldwide Regional Approvals	218
Important Note	218
Appendix H - Declaration of Conformity.....	219
Appendix I - Warranty.....	220

Introduction / Overview

Broadweigh is a portable modular wireless weighing system offering real-time load monitoring for a wide variety of rigging applications without the need for cabling.

Broadweigh enables users to know precise loads on any given point thereby ensuring structures and rigging points are balanced and within safe working loads.

A user-friendly wireless Handheld Telemetry Display provides load monitoring of any Broadweigh Shackle. In addition a PC interface can be used to view and log multiple inputs on a single screen via the use of the Broadweigh Log100 Software and USB Base Station.



 In Q4 2020 shackles have been updated with the following:

- 1 Support for Smart Sleep
- 2 Holds maximum weight value seen whilst in operation
- 3 Holds last calibrated date
- 4 New stainless steel, black bow
- 5 Magnetic power disconnection module for easy pairing with magnetic fob

These shackles are marked 'Gen 3' on their silver labels or contain version 6.0 or above firmware. In this manual these features will be referred to as **Gen 3**.

Navigating This Manual

When viewing this PDF manual the following tips will help you navigate.

Viewing bookmarks ( or ) to the left of the page, in the PDF viewer, will allow easy navigation to the relevant chapters of this manual. Alt-left arrow is a useful shortcut back to the last page viewed after a hyperlink is clicked. Hyperlinks are coloured orange and are underlined.

Safe Use

Designed to aid rigging professionals on a daily basis, the Broadweigh wireless load cell shackles offer simple, real-time, effective and accurate load monitoring. It allows users to know the **precise loads on any given rigging point, guy wire or hoist in a rigging system. This valuable data** enables the rigger to safely distribute weight for indeterminate loads, roof structures and mother-grids as well as indicate alarms to avoid overload situations.

The Broadweigh Shackle is a bow shackle with load pin and integrated electronics which features the following:

- Available in 9 tonne, 4¾ tonne or 3¾ tonne WLL options
- Up to 800 m line of sight wireless transmission range
- IP67
- 5:1 safety factor
- Low rigging profile from 60 mm
- 2000 hr battery life at transmission 1 per second
- Smart Sleep function to preserve battery life when not needed
- Accuracy of $\pm 1\%$ of current load or 25 kg (50 kg for 9 tonne), whichever is the greater value (When using original bobbin or TwistLink. There may be a reduction in accuracy if these are swapped.)

Shackles must be correctly selected for the specific application required. As well as safe working load, physical size and fitment with other components needs to be considered.

The shackle pin and bow are calibrated and load tested together. It is therefore essential for the accuracy of the system that the following information is adhered to:

- Each pin and bow must be kept as a pair and not interchanged. The bow is marked with the ID of the pin it is associated with as shown.
- The pin must be aligned in the same orientation with the bow as it was when calibrated.
- The Broadweigh shackle is calibrated with the shackle markings and the label visible as shown below.
- The shackle must be used in conjunction with a bobbin or TwistLink, nut and retaining clip as shown:

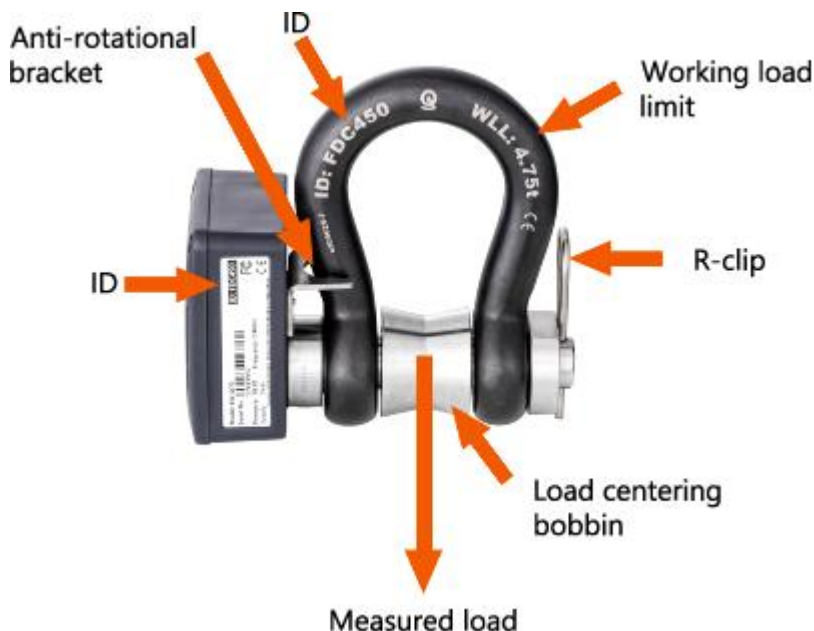

i If using a TwistLink, ensure that the load sensing pin is in the side of the TwistLink marked 'Sensor'.

Any out of alignment, side or twist loading will affect the readings given as well as load the shackle in a way that it was not designed for.

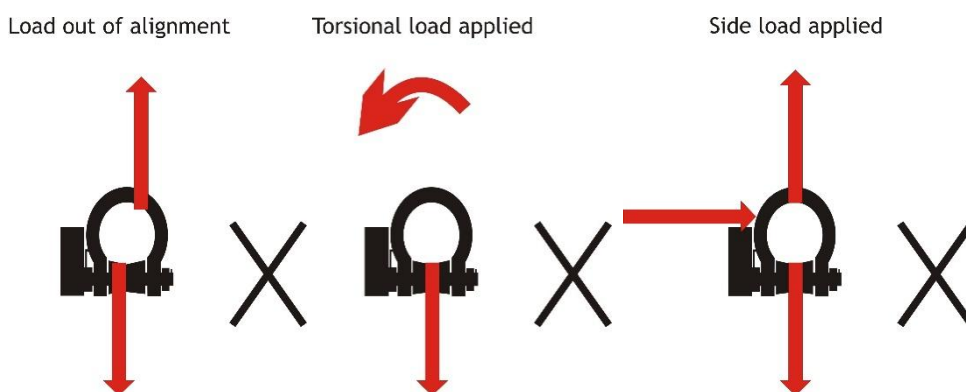

If using the shackle as part of a bridle, remember that the load in legs of the bridle will increase with the angle. If the Broadweigh shackle pin is not connected to that part of the leg then it will not register this increase.

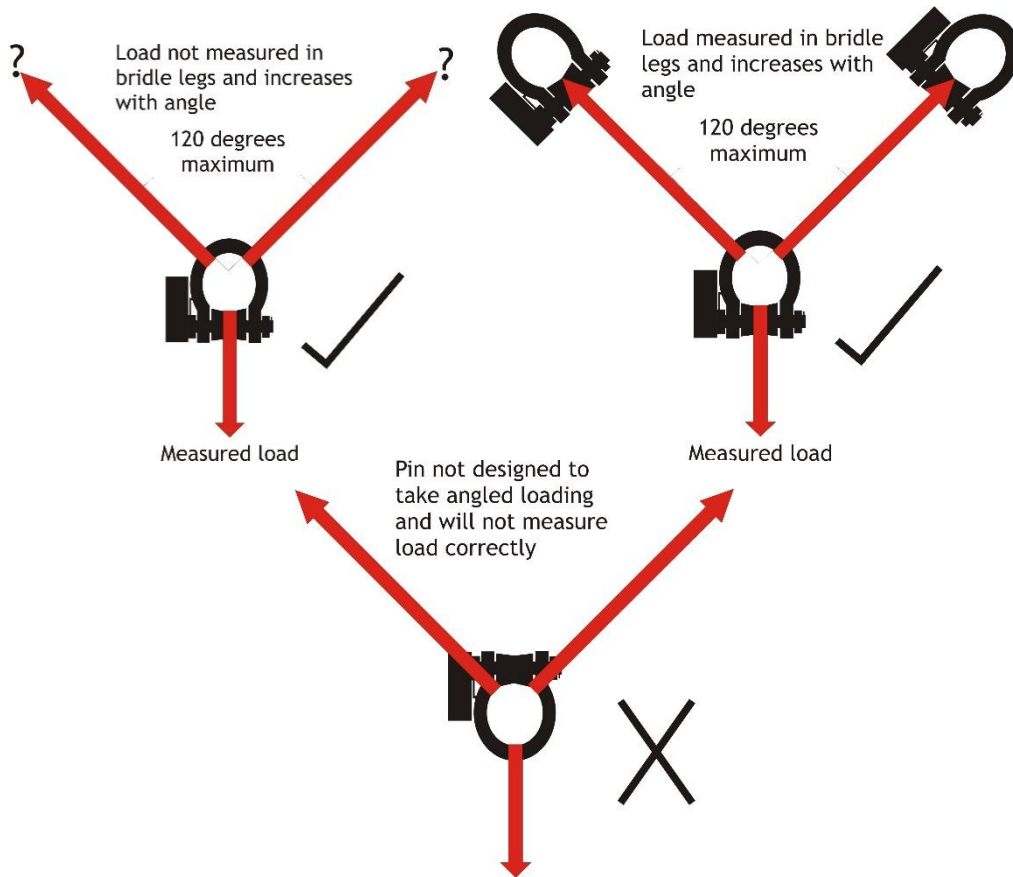

No part of the shackle, pin, bobbin or TwistLink should be modified by welding, grinding or similar.

Always ensure that the load is stable.

The allowable operating temperature range is -20°C to +50°C.

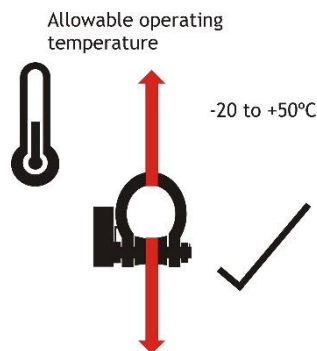

The working load limit (WLL) of Broadweigh shackles and TwistLinks assumes the absence of exceptionally hazardous conditions. These include offshore activities, lifting of persons and lifting of potentially dangerous loads such as molten metals. In such cases the degree of hazard should be assessed by a competent person and the safe working load (SWL) reduced accordingly from the working load limit.

The product should never be used above the WLL. If the WLL is exceeded the unit should be removed from use and a BroadWeigh representative contacted. When Gen 3 shackles are paired in the Toolkit, you can see the highest measured load that the shackle has seen. If this is greater than the WLL of the shackle it must be returned to Broadweigh for evaluation to ensure its continued safety.

Please remember that Broadweigh does not give advice as to how the data from Broadweigh shackles is used. All lifting operations are different and must be supervised by suitably qualified and experienced riggers. It is the user's responsibility to ensure conformity with local regulations.

Broadweigh is not designed to be used as part of a safety critical control system. If it is required for one then the integrator would need to fully assess its suitability.

Broadweigh bows are subjected to a 200% proof load (static test coefficient of 2) and Broadweigh pins are subjected to a 150% proof load (static test coefficient of 1.5) before being calibrated as a whole assembly.

Inspection and Maintenance

As with all rigging equipment, Broadweigh shackles and TwistLinks should be inspected before and after every use, ensuring that all the components are present and correct (bow, pin, bobbin or TwistLink, nut and r clip) and the serial IDs match. All load bearing components must be free from cuts, nicks, cracks, gouges or excessive wear and distortion. Any damaged Broadweigh shackles or components must be taken out of service and returned to your dealer to arrange refurbishment or scrapping. If you attempt to replace or swap any load bearing parts yourself the unit's calibration will be void.

It is also important before every use to check that all the settings are as expected. The most safety critical settings to check are that the system zero and the units are correctly set (see the relevant sections in the manual). If these have been unknowingly changed you could end up with unexpected and misleading readings.

Before moving offset or checking any readings please ensure that the shackle's temperature has stabilised. When moved from different temperatures it can take up to an hour to reach the local ambient temperature. Once it has done so, the readings can accurately be checked.

Always remember that damage to the shackle or its calibration can happen at any time. If you need to move the zero offset significantly then further investigation is required. This could take the form of a thorough examination and calibration check with a known load. Records should be kept of any calibration check so that you can see any movement over time. If the readings are out by more than 1 % or 25 kg (50 kg for 9 tonne) or you have to zero out more than 50 kg, please return to your dealer to arrange recalibration. (Remember that the bobbin must be centred and the pin perpendicular to the load to get the most accurate reading).

These measures should be used in conjunction with your own thorough examination routine at the same intervals you have set for normal shackles. This will vary due to local regulations but should not be less than every 6 months. Records of all thorough examinations should be kept.

In line with the Lifting Equipment Engineers Association (LEEA) guidance we would recommend returning your shackle to the factory every twelve months for re-calibration. You may also choose to check your shackle's output with a known load more often than that.

When Gen 3 shackles are paired in the Toolkit, you can see the highest measured load that the shackle has seen. If this is greater than the WLL of the shackle it must be returned to Broadweigh for evaluation to ensure its continued safety.

There are very few maintenance requirements. The Broadweigh shackles, TwistLinks and battery enclosures need to be kept clean, threads clear of debris and protected from corrosion.

Do not overtighten screws when replacing batteries. Damage caused by overtightening is not covered under manufacturer warranty.

Remove the batteries if being stored for an extended period. Leaking batteries can damage the circuitry.

Product Quick Locator

This section allows you to locate your product quickly to navigate to the correct section of the manual.

Shackles

[BW-S325](#)

[BW-S475](#)

[BW-S475-TL](#)

[BW-TL](#)

[BW-S900](#)

Base Station

[BW-BSue](#)

[BW-BSd](#)

[BW-BSi](#)

Handheld Display

[BW-HK-S](#)

[BW-HR](#)

[BW-HA](#)

Relay Output

[BW-RM1](#)

Alarms

[BW-WM1](#)

Active Repeater

[BW-AR](#)

Wind Speed Sensor

[BW-WSS](#)

Power Supplies

[SP1](#)

[PP1](#)

Broadweigh Basic Principles

There are some basic radio settings and concepts that should be understood to effectively configure, deploy, optimise and troubleshoot Broadweigh telemetry systems.

Transmitters & Receivers

Although all of the Broadweigh modules are in fact transceivers and transmit as well as receive, they tend to mainly operate as either a transmitter or receiver so we will choose to describe them as **Transmitters** and **Receivers**. The Broadweigh system was designed so that Transmitters are configured to send out messages at a user defined rate. Receivers can then use this data to analyse, display or perform other actions depending on their function. A PC and base station are only required to configure the modules although they may be part of a data collection system. Once configured the Broadweigh modules operate autonomously and only minimal control over the Transmitter modules is usually required, by Receiver modules, such as sleeping or waking.

Transmitters

These are the sensor modules that measure weight or wind speed etc and send messages containing the value and status information at regular intervals for use by Receiver modules or for delivering to a PC via a base station. Because these modules need to be very power efficient to operate on batteries they operate in three distinct modes. See [Transmitter Module Modes of Operation](#) later.

Receivers

These modules use messages provided by Transmitters and have functionality such as handheld displays or relay modules. These modules may also offer control over Transmitter modules such as sleeping or waking.

Radio Channel and Group Key

To be able to communicate, two radio modules must share some basic settings. There are ways to learn these and to recover unknown settings and these are discussed later in the [pairing](#) section.

Radio Channel

This is the frequency that the radio operates on. Broadweigh radio bandwidth is divided into 15 channels. Modules must be on the same channel to be able to transfer messages.

Group Key

Group keys are a way of isolating groups of modules even if they are operating on the same radio channel. This can improve efficiency and also offer security because no radio module can affect another or see their messages unless they share the same group key.

A group key is defined by the user and is up to 15 alphanumeric characters.

Group keys were introduced in v3.0 radio firmware in June 2015. New radio modules will work with older radio modules but group keys cannot be used.

Configuring Multiple Modules to Use the Same Radio Settings

Please note that when you pair to a remote module the base station adopts the radio channel and group key of the remote module.

To set the group key for a set of remote modules you can either:

Pair to each one in turn and set their radio channel and group key

or

Configure the base station by holding the shift key and clicking the **Pair** button on the [Home](#) page. Then configure the base station to the required [radio settings](#). Next use the tool on the [radio settings advanced](#) page to pair to each module in the set to configure their radio settings to match the base station.

ID and Data Tags

To configure a module its **ID** is used in communications. This is a unique 6 character identifier, such as **FF1234**, which is allocated at the factory. This ID is hexadecimal so can consist of numbers 0-9 and letters A-F.

If a module is a Transmitter it sends messages without broadcasting its ID. It identifies messages by using a Data Tag. This tag is a 4 character hexadecimal number and can be configured by the user. When modules leave the factory this data tag is set to the last 4 characters of its ID.

When Receiver modules or software want to use messages sent by Transmitter modules they identify the message they want by this Data Tag.

The reason Transmitter module messages are identified by a Data Tag rather than the unique ID is that this allows replacement of a Transmitter module without having to reconfigure the many Receiver modules that may be using its messages. It is only necessary to configure the replacement Transmitter module with the same data tag, radio channel and group key and the rest of the system will not notice the difference.

Transmitter Module Modes of Operation

Normal

Normal mode involves taking a reading and sending a message then entering into a very low power state before taking the next reading to maximise battery life.

Because it is not possible to communicate with the Transmitter module during this low power state a 'configuration' mode is required.

Configuration

Configuration mode forces the modules to pause in sending their messages and to disable their low power state to enable configuration to take place. This is easily achieved by '**Pairing**' when using the Broadweigh Toolkit software. Once configuration is complete the modules will resume their '**normal**' mode operation.

Sleep

The last mode is sleep. Modules can be sent to sleep by other modules or they can go to sleep themselves when their messages are no longer being used. See **Sleep Delay Settings** later.

When sleeping, the modules can be awakened on demand by other modules or software via the base station.

Smart Sleep

For **Gen 3** shackles Smart Sleep was introduced and replaces the standard Sleep. Unlike standard Sleep mode, Smart Sleep adds two important features.

Transmissions still take place at a new reduced rate. This defaults to a transmission every 10 seconds. In some cases this is a good enough rate for the system to operate at permanently so the shackles need never be woken (Where they would transmit at a faster rate which is every second by default).

The second feature is that the shackles can automatically wake when the weight changes thus automatically providing data at a faster rate when changes to the load have occurred and so the data becomes more interesting.

Disabling smart sleep enables shackles to operate as before.

Transmitter Module Sleep Delay Settings

Transmitter modules have a **Sleep Delay** setting (set in seconds) which allows the modules to go into Sleep or Smart Sleep mode when their data messages are no longer required. This allows much longer battery life to be achieved.

Setting Sleep Delay to zero disables this function in the Transmitter modules and they will only go into Sleep mode when told to do so.

Most Receiver modules and Broadweigh software send **Stay Awake** messages when they see messages arrive from Transmitter modules. In the Transmitter modules, if the Sleep Delay time period has elapsed without a Stay Awake message arriving then the module will enter Sleep mode.

Usually the Stay Awake messages are sent every 5 seconds so Sleep Delays should be set to at least 10 seconds but can be set to anything up to an hour for situations where the Receiver is likely to be out of range for periods of time but where the Transmitter module is required to stay awake and in normal operational mode during that time. Sleep Delays default to 900 seconds when in simple configuration mode but could be manually configured less than this but it is not recommended to set below 30 seconds.

Pairing

Because you need to know the radio settings configured in a module to be able to configure it, and there are no visible clues to what those settings may be, there is a feature used by Broadweigh modules that enable the radio settings (i.e. the radio channel and the group key) to be determined and matched between two Broadweigh modules.

Pairing is only required to determine and match radio settings and optionally to put Broadweigh Transmitter modules in **configuration mode**. Because in some installations the Broadweigh modules can be buried deep inside other equipment there had to be a way of indicating that a module has been selected to pair with without having physical access to that module. Pairing was therefore designed to be activated by removing and re-applying the module's power. In some cases this is not practical so another possible solution is [Soft Pairing](#).

Gen 3 shackles are manufactured with a magnetic power disconnection module which allows them to be power cycled for pairing without having to remove the lid or batteries.

- Hold fob with the flat side against the middle of the underside of the enclosure.
- Press the Pair button in the toolkit
- Move the fob away from the enclosure in one swift motion

Make sure that the fob is moved far enough away so as not to keep triggering the disconnection module as this could result in a poor pair.



This module is also available to retrofit to shackles so it is not apparent from looking at a shackles build revision or firmware revision whether it supports this feature.

Flight case inserts will be available with integrated magnet which will automatically disconnect the power from shackles while they are stored in the flight case. Suitably placed magnets placed in existing storage inserts would also allow batteries to be disconnected automatically.

Pairing From Broadweigh Toolkit

When using the Broadweigh Toolkit and a base station, pairing is used to connect to a module without having to know anything about it beforehand. To pair, remove power from the required module, click a 'Pair' button in the software and re-apply power to the module. The base station and module negotiate settings and the **base station is automatically configured to match the radio settings from the module** and places the module into configuration mode. Now the module can be configured and when complete it will return to normal operational mode.

Pairing From a Receiver Module

Some Receiver modules allow pairing to a Transmitter module without requiring the Broadweigh Toolkit. For example, the BW-HR handheld display offers this feature by turning it on while holding a certain key after which the power is applied to the Transmitter module. The radio settings are then negotiated and the **Transmitter module is automatically configured to match the handheld radio settings**. The handheld learns the ID and data tags required to be able to use messages from the Transmitter module. In this case no configuration mode is required so the Transmitter module simply continues to operate in normal mode but with altered radio settings.

Soft Pairing

Pairing by power cycling is absolute and will work under all circumstances (where there is sufficient radio signal and bandwidth on channel 16 and the currently selected radio channel). However, sometimes access to the power supply of a module that you want to pair to can be restricted, a module 20 meters up a tower for example, so the Broadweigh Toolkit offers a way to *soft pair*.

To achieve this you need to know the radio channel and group key of the remote module and configure the base station to match this. You must also know the unique ID of the module and armed with this you can soft pair to the module. This works well with Receiver modules as they are not operating in low power modes but the software does need to try and change Transmitter modules from their normal operation mode into configuration mode therefore modules with transmission intervals greater than 5 seconds may be difficult to soft pair to.

This may not **always** work reliably in high traffic or high noise environments because there are a lot of messages that need to be sent between the base station and the remote module which can be upset by the presence of too many other messages on the same radio channel.

Configuring an Attached Base Station

Because a base station is attached to your computer when you are using the Broadweigh Toolkit you do not pair to it the same way as with other Broadweigh modules. To configure the base station using the Toolkit hold the shift key and click the **Pair** button on the [Home](#) page.

Asynchronous Operation and Logging

Transmitters send their messages at a fixed user defined interval regardless of whether anything is listening. This **message interval** is timed from when the Transmitter has been woken or powered on so there is no synchronisation of when the actual measurement is taken between different transmitters.

If you are logging information from multiple Transmitters using multiple channel logging software you should be aware of how the software will store and record values.

The software stores the message values as they arrive from each Transmitter and when a log is to be recorded it is the last value received by each Transmitter that is used.

This means that the values that are recorded could have been measured at any point during the Transmitter message interval.

For example, if there are 10 Transmitters operating at 1000 ms message interval then when the values are recorded to the log file you can **only** be sure that those values had been recorded within 1000 ms of each other.

So if there is a requirement that recorded sets of readings are within a certain time of each other, then that time is the maximum message interval that should be set for the Transmitters regardless of the actual log interval of the software (Which should always be greater than the Transmitter message interval).

Bandwidth

Each radio channel (1-15) has a finite ability to carry information. When modules do not need to communicate with each other they can be configured on separate radio channels and do not affect each other.

However, when multiple modules are on the same radio channel, even if they use different group keys, they are all contributing to filling the available bandwidth.

Each message transmitted takes up around 3 milliseconds so if everything worked perfectly and all modules transmitted at just the right time and with no gaps between then there could only ever be 300 messages per second being transmitted on any one radio channel.

In reality there are factors that reduce this capacity.

Each module uses a technique to detect whether anyone else is transmitting before it transmits itself and this takes a finite time. There can also be interference from other sources that can delay module transmissions.

Because of the transmission rate flexibility of the Broadweigh modules there could be a few modules transmitting messages at fast rates or many modules transmitting messages at slow rates or any combination of these.

Practically there is a limit of around 200 messages per second available per radio channel.

It should be noted that as the number of Transmitter modules increases there is more chance of message collisions and so more messages are lost (remember that the Transmitter modules are sending their messages out at regular intervals) thus reducing the average number of messages per second arriving per module.

So, for example, 2 modules may transmit at 100 times per second or 100 modules at a rate of 1 per second.

Repeaters and Repeater Subgroups

Repeaters are able to retransmit messages so that the repeated signal is stronger than the original and so can increase the range of systems or can bypass obstacles.

The repeater must be configured to operate on the same radio channel and use the same group keys as those modules it is repeating.

Because the radio traffic is effectively doubled by a repeater there is a mechanism to reduce unnecessary repetition of messages.

Sometimes a repeater will still see messages from modules that do not need to be repeated (Thus filling up available **bandwidth**) so both repeaters and all other Broadweigh modules have a setting called the repeater subgroup.

By default all subgroup settings are set to zero. A repeater will repeat a message from all modules whose subgroup is either zero or matches its own subgroup. If a repeater subgroup is zero it will repeat messages from all modules.

This is a simple way to break down modules into smaller groups and control what messages get repeated.

Changing the repeater subgroup is not normally necessary unless the bandwidth is very full due to either many Transmitter modules being present or very fast transmissions from modules.

So, for example, 2 modules may transmit at 100 times per second or 100 modules at a rate of 1 per second.

Broadweigh Toolkit

To configure the modules you must use the **Broadweigh Toolkit** software application. This can be downloaded from our web site or may be shipped with your products.

The software is suitable for all versions of Windows.

Run setup.exe and follow the prompts to install the software.

In the Toolkit all items that can be changed or interacted with by the user are coloured orange.

To change a value just click on the relevant orange item. You will then be presented with a new dialog window allowing you to change the value.

This may use a slider, text box or list to allow your new value to be entered.

A base station will also be required to configure the Broadweigh modules. You just need to plug this into a USB socket on your PC.



Do not pair to multiple modules with multiple instances of the toolkit at the same time.

Common Toolkit Pages

These pages in the Broadweigh Toolkit are common to many connected modules.

Double-clicking the icon in the top left of the window will place a screenshot image of the current page into the clipboard.

Setup Base Station Communications

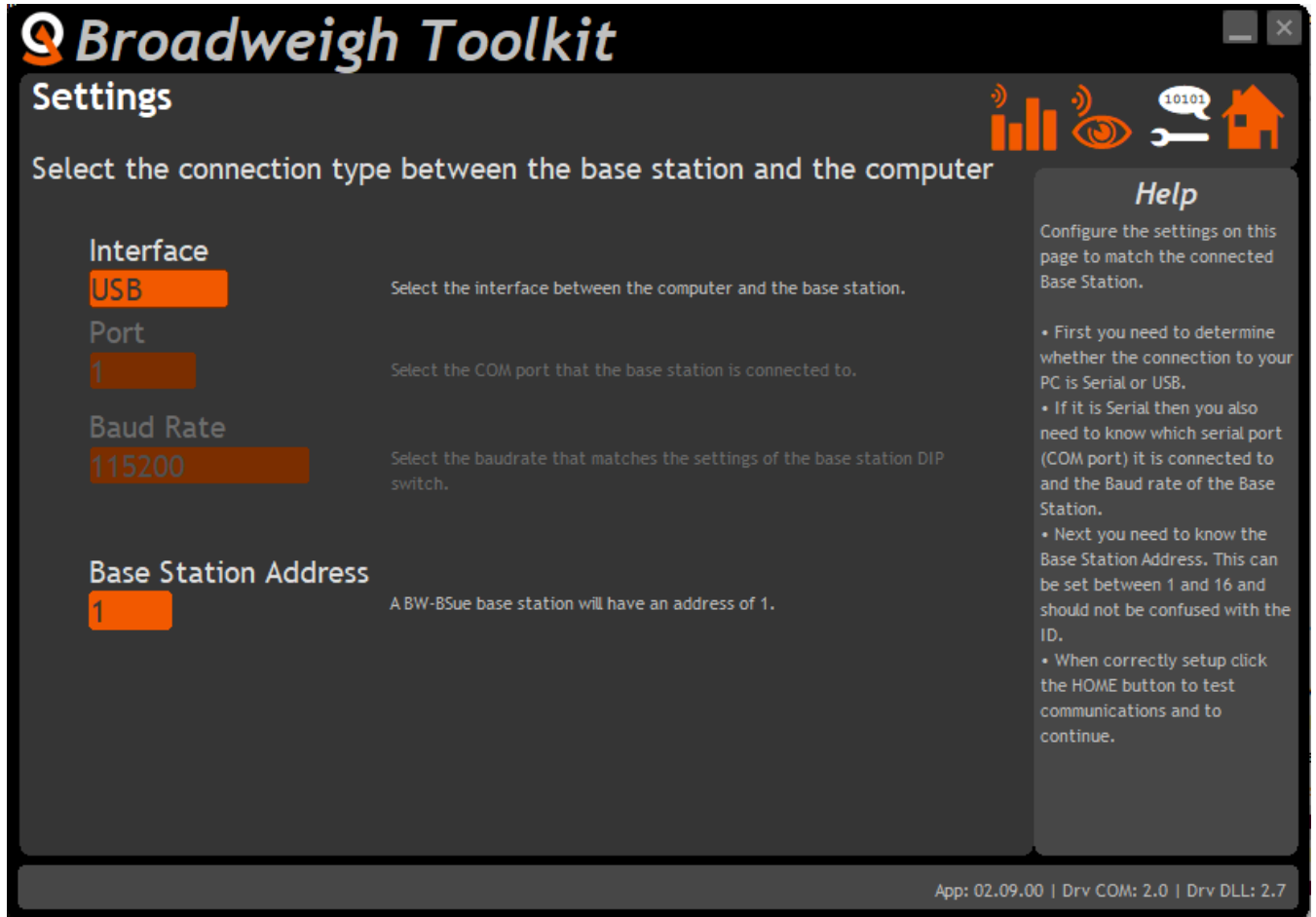

Select the appropriate interface type for the connected base station. This will usually be USB. If the base station is connected via a serial port then you will need to know the COM port it is connected to and the baud rate.

The Base Station Address is usually 1. This will only ever be different if it has been changed on base stations to support multi base station configurations.

Click the Home button to attempt communications with the base station.

If no communications can be established the toolkit will remain on this page. You will need to check that the base station is powered and that it is connected to any converters correctly.

Spectrum Analyser

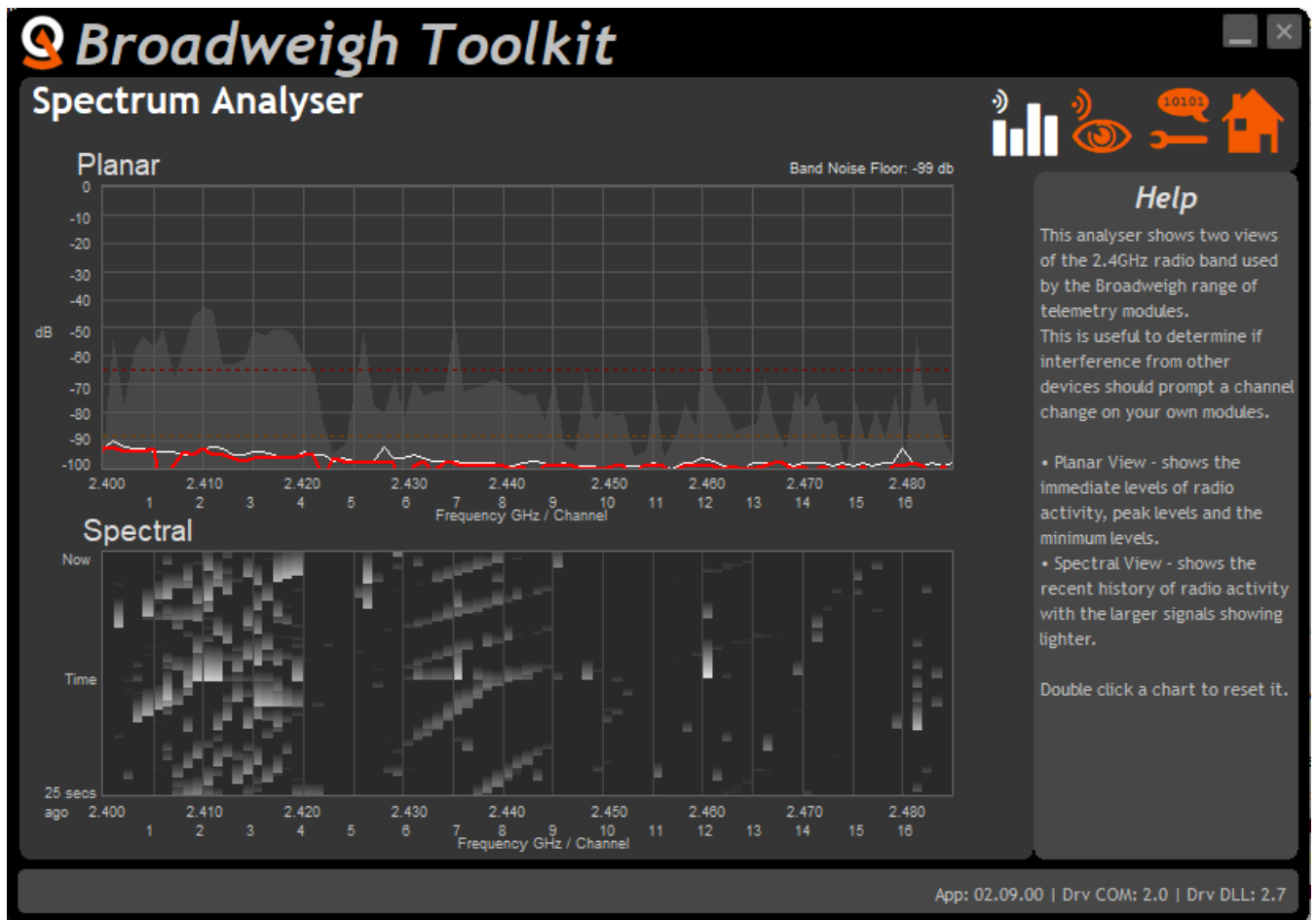

The spectrum analyser page is provided as a tool to use when conducting a site survey before installation, or to diagnose poor communications issues.

This page shows the radio signal levels detected across all the channels available to the Broadweigh series of modules. Using this tool may help in detecting noisy areas and allow you to decide on which channels you may want to use.

Although 16 channels are shown the Broadweigh modules operate over radio channels 1 to 15. Channel 16 is reserved for pairing negotiation.

Planar View Parts

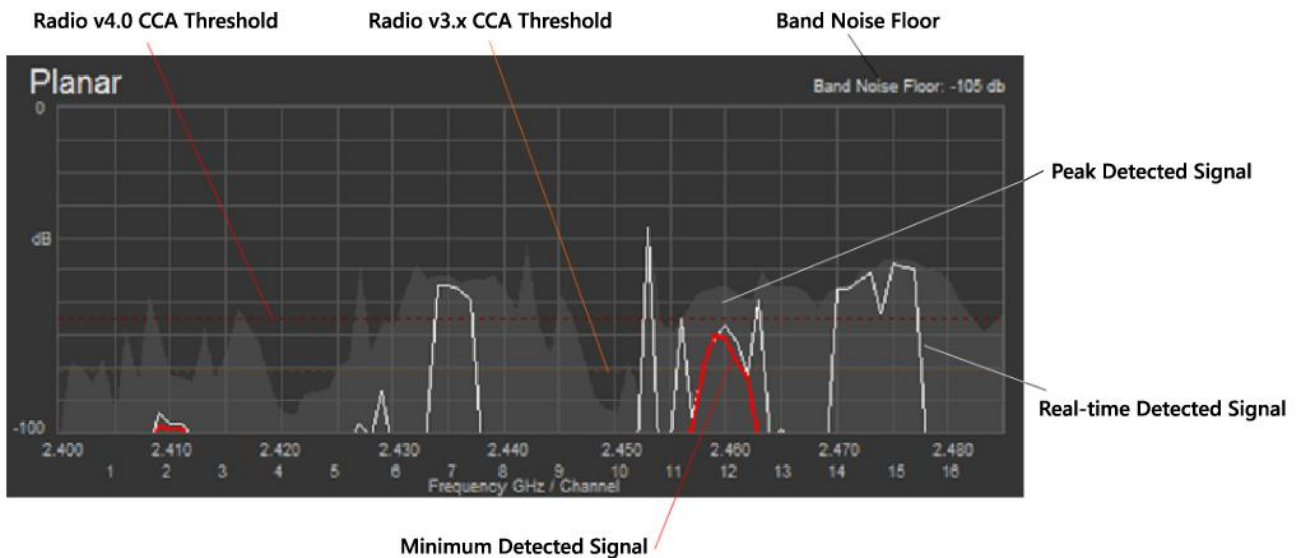

Note that the detection is taking place **at the base station** so it may be necessary to attach a base station to a laptop to enable a full environmental survey to be undertaken.

Real-time Detected Signal

The white trace shows the real-time level of detected signal. On its own this information only really indicates where other radios are operating. Broadweigh works fine with other transmissions but you may want to stay away from channels that have a lot of activity when there are other quiet channels available.

Peak Detected Signal

The shaded background shows the peak signal detected across the band. This is more useful than the real-time trace because, over time, this build a picture of where the traffic has the highest power.

Minimum Detected Signal

The red trace is very important and shows the minimum signal level detected across the band. In a good, quiet RF environment these red traces will not be visible but where there is a high level of broadband noise or very high amounts of radio traffic you may see channels that show red areas. As long as these remain below the CCA (Clear Channel Assessment) thresholds for the Broadweigh radio modules deployed ($\leq v3.x$ or $\geq v4.0$) the Broadweigh radios will still operate but given the choice select a channel that does not show a high minimum signal level.

As levels start to increase above -95db this will start to reduce maximum achievable radio range.

Band Noise Floor

This indicates the lowest signal level across the entire band. Usually this will be off the bottom of the chart but when this is visible it can indicate underlying issues with the environment that could affect the Broadweigh radio operation. As levels start to increase above -95db this will start to reduce maximum achievable radio range.

Radio v3.x CCA Threshold

This orange dotted line indicates the signal level at which the version 3.x (and below) radio firmware will not transmit. Any signals detected larger than this level will stop the module from transmitting. Usually this is not a problem as Broadweigh radio works in harmony with other radio systems and will transmit in the gaps between other radio transmissions. However, if the Minimum Detected Signal is close to, or above, this level then the Broadweigh radio system will cease to function.

Radio v4.0 CCA Threshold

Version 4.0 radio modules have a revised CCA threshold to allow them to work better in high noise RF environments.

Version 5.0 Radio

Version 5.0 radio modules (Fitted on all **Gen 3** shackles) have an adaptive CCA threshold which starts off at the red dotted line but will drop to the orange dotted line as the channel noise floor is tracked. If the noise floor increases the CCA threshold will adapt. This adaptive nature allows for the lowest CCA threshold required to transmit successfully but to avoid transmitting over other far located transmitters as long as their signal level is above the noise floor.

Examples

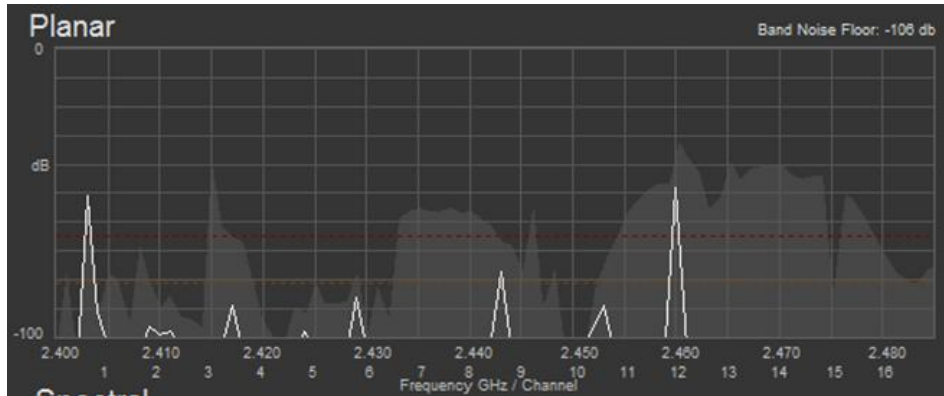

This shows a good RF environment. The Band Noise Floor is low and there are no red traces indicating that there are plenty of signal free gaps to enable Broadweigh to transmit. There is traffic across the whole band with higher signal traffic between channels 11 to 15, but there is nothing that would affect Broadweigh operation.

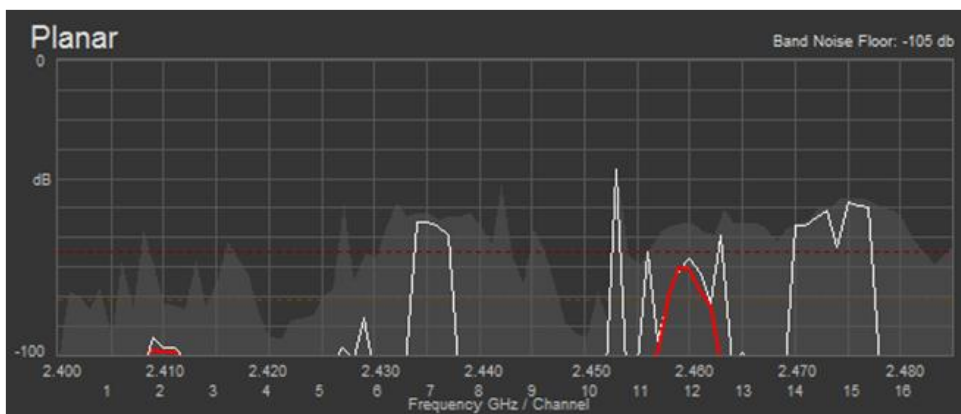

Here we can see some visible red traces indicating the minimum signal levels. Around channel 2 there is something transmitting constantly but the signal is so low that Broadweigh would operate fine anyway. However, channel 12 shows that there is a constant transmission that is above the v3.x radio CCA threshold so those Broadweigh radios would not function on channel 12. Version 4.0 and above Broadweigh radios would function but communications may be erratic and certainly the range and coverage would be reduced. It would not be a good idea to use channel 12.

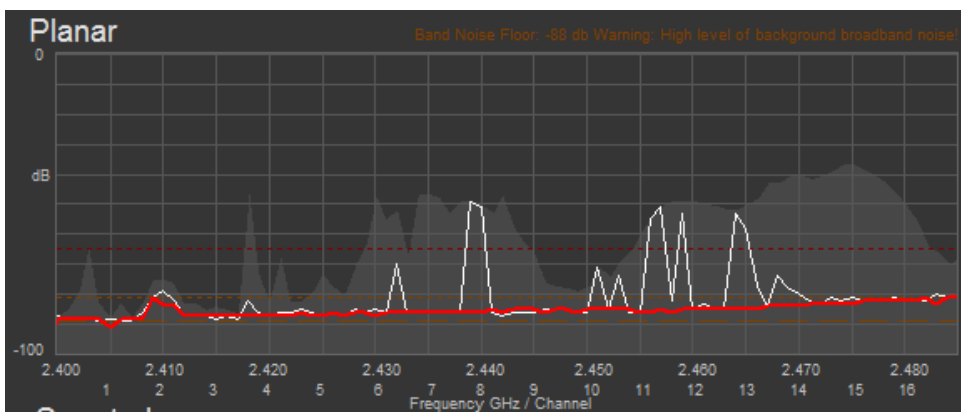

Above we can see a scenario where the entire band noise floor is high. This means that across all channels the range achievable will be reduced because Broadweigh transmissions from distant modules will be swamped by the constant signal from the noise floor. For most channels the minimum signal level is below the CCA threshold, so as long as the Broadweigh signal is strong enough the system will still work. However, note the sloping nature of the red trace. At around channel 16 the minimum signal level is at the level of the v3.x radio CCA threshold so version 3.x radios would not be able to pair because channel 16 is used in the pairing negotiation. V4.0 radios would still operate successfully.

! Certain PC USB 3.0 ports that are unshielded are known to have radio emission issues that can result in exactly the above scenario. This will always have the effect of reducing the operating range if a USB base station is used and the antenna is positioned close to the USB 3.0 port. This affects base station dongles mostly, but can affect any base station placed close to the USB port. Not all USB 3.0 ports exhibit this problem. Plugging into an adjacent USB 2.0 port may or may not fix the issue depending on internal PC architecture. Use a USB port away from USB 3.0 ports or use a short USB extension cable if affected. This affects all 2.4GHz electronics and transmitters not just Broadweigh.

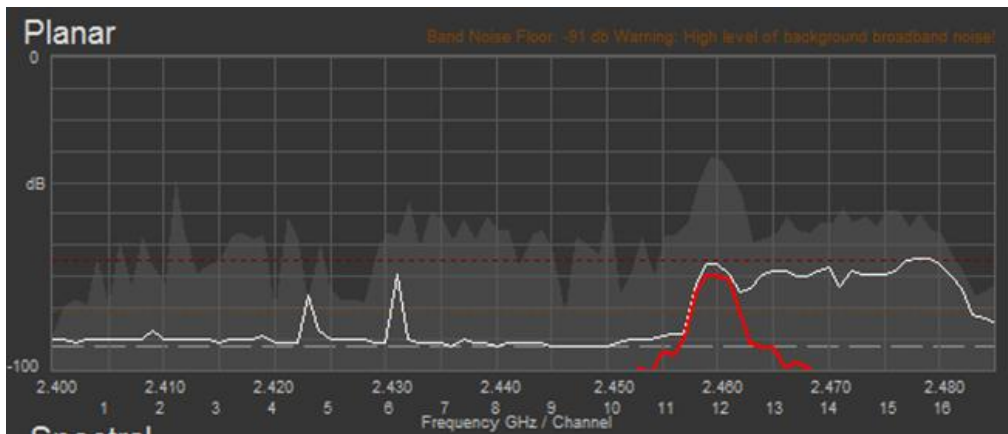

This shows how the display would look if the band noise floor slowly crept up. The red trace is only visible on channel 12 but other channels that were once OK (Having a very low minimum signal level) now have a viewable level of minimum signal noise. A double-click on the planar chart would reset the peak and minimum calculations so the minimum red trace would then follow the more recent higher noise floor.

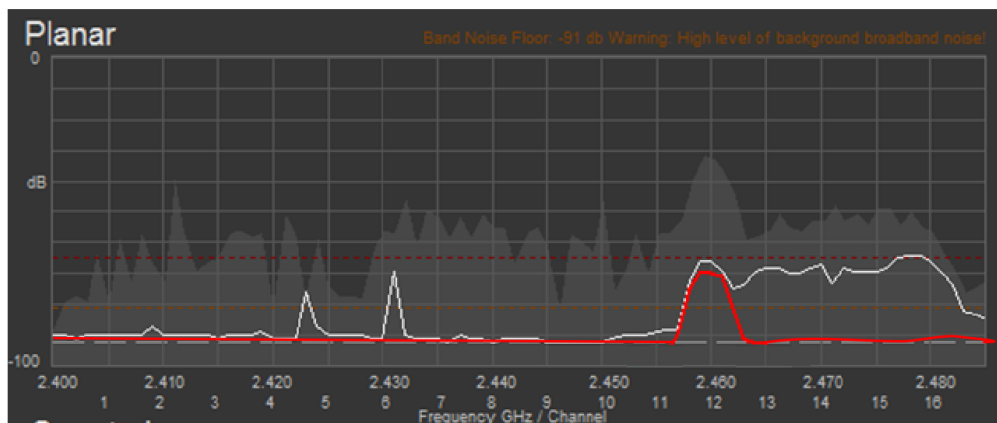

Channel Monitor

Data Tag/ID	Total	Transmission Rate	LQI	Value	Warnings
FFF2	6	not transmitting	000	29.38827	
FFF1	6	every 5 seconds	100	13.72713	

NOTE: The base station has a Group Key set so it will only see modules with the same Group Key!

Pressing the Start Logging button will allow you to select a filename to log the data to. This will be in CSV format. Pressing the View Last Log button will attempt to open the log file in the associated application.

Buttons: Clear List, Wake All, Move Group Channel, View Last Log, Start Logging

Help: This page allows you to monitor data transmitted by acquisition modules with a Group Key that matches the base station. You have the option of logging the values to a comma separated value (CSV) file. Click the Wake All button to wake all modules with the same radio settings as the base station. If the Move Group Channel button is visible (When using a Group Key) you can move all modules in the group to another radio channel. Double click an item to manually connect to it for configuration. The full module ID will be required to achieve this.

App: 02.09.00 | Drv COM: 2.0 | Drv DLL: 2.7

This page shows a summary of data sent by transmitter modules.

You can see the Data Tag of transmitted messages along with the total number of messages received, the transmission rate, link quality, data value and any error messages.

Base stations built after June 2015 can also list modules that are sleeping. These will show an ID instead of a Data Tag.

Gen 3 shackles with Smart Sleep will show a line entry for both sleeping ID and transmitting Data Tag.

i To see any data the base station must be on the **same** radio channel as the transmitters and must have a **matching** Group Key

The radio channel of the base station can be changed by clicking the channel tabs along the top of the page.

If you want to change the Group Key of the attached base station you need to configure its radio settings. See [Configure Base Station](#)

Items you can change or interact with:

- | | |
|--------------------|--|
| Radio Channel Tabs | Click a tab to change the radio channel the base station is operating on |
| Clear List | Clear all detected messages from the list |
| Wake All | Wake all modules on the current radio channel |

Start Logging

Asks for a filename then logs the received data to a CSV file in the following format:

Data Tag, Elapsed ms, Value

View Last Log

Will launch the application associated with CSV files and open the last logged file.

Move Group Channel

If the base station has a group key set then this button will be visible. Once at least one module is present in the list this button will become enabled. Clicking it will ask the user for a new radio channel then all detected transmitters, along with any other modules on the same channel such as handhelds, will all be moved to the selected channel. Once this has been achieved the base station itself will move and the list will start to fill again with messages on the new radio channel.



You will only see a list of detected transmitters on this page so you will need to ensure that any other receiver modules in the group are available to be woken.
When this button is clicked all modules on the same radio channel and group key will be woken before they are changed to the target radio channel.



View Real-Time RSS

If the base station has version 4.1 or greater radio firmware this icon will be displayed in the top right of the tabbed viewport. Click to view the real-time RSSI levels and allocated adaptive clear channel assessment (CCA) threshold level.

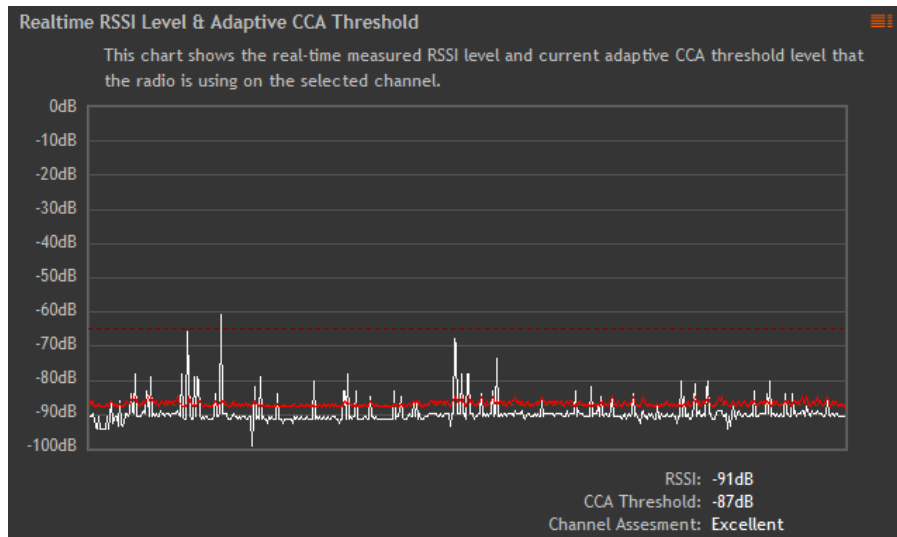

The white trace shows the real-time, sampled RSSI levels and the red trace shows the current CCA threshold allocated for the current radio channel environment. This chart shows only representative RSSI levels as it is sampled at 10Hz but the important property is the lowest RSSI levels seen as this is what is used to determine the CCA threshold to use.

In simple terms the transmitter will be able to transmit when the detected RSSI level is lower than the red trace.

The text below the chart assesses the channel suitability and reports depending on the currently allocated CCA threshold level.

- > -66 Critical, >-70 Very Poor, > -75 Poor, > -80 OK,
- > -85 Very Good, >= -88 Excellent

The selected channel may be assessed as excellent in terms of its background RSSI noise level but may still be unsuitable due to too much traffic.



Return to view received packet list.

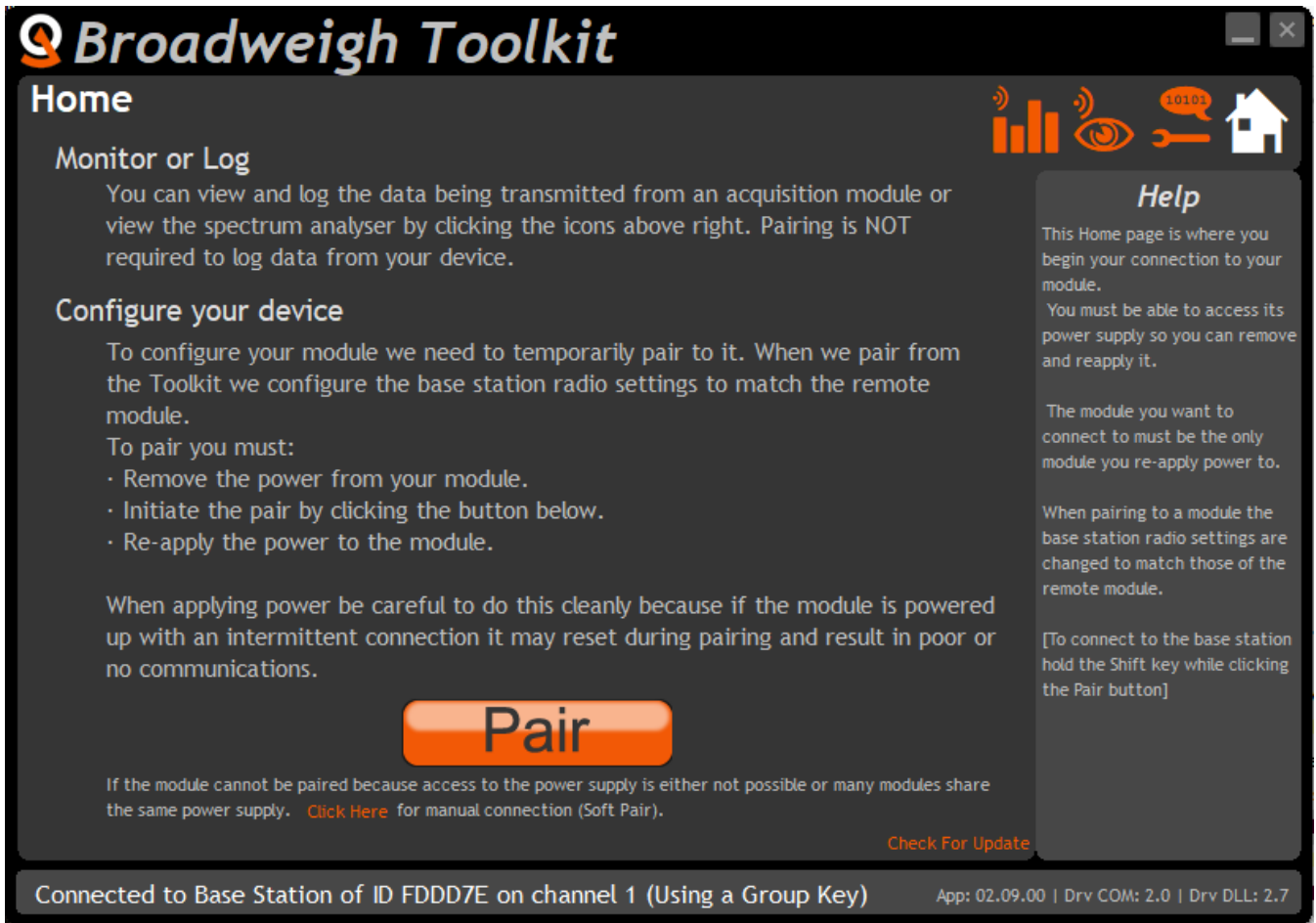

You now have successful communications with the base station so you can now pair with our remote Broadweigh module or you can select the Spectrum Analyser mode or Data Provider Monitor mode.

Connecting to a remote module

To connect to a remote module you will pair. This is achieved by power cycling the module. Pairing removes the need to know the radio settings of the module you are connecting to and also ensures that it is in a suitable state for configuration.

Pairing Procedure

- Remove power from the Broadweigh module.
- Click the Pair button on the Toolkit.
- Re-apply power to the Broadweigh module within 10 seconds.
- **Alternatively**, with **Gen 3** shackles (and other shackles fitted with a magnetic switch) click the pair button in the Toolkit then use the fob as described in the [Pairing](#) section.

When you connect successfully the Toolkit will change to the [Information](#) page. If the pairing fails try again.

- i** Pairing with the toolkit will **not** change the radio configuration settings of the connected module. The base station radio settings will be changed to match those of the remote module.
- i** When the toolkit connects to a remote module to enable configuration it will usually inhibit the normal operational transmission of messages

Connecting to the attached base station module

To pair to and configure the connected base station, hold the shift key and click the Pair button.

Manual Connection

If you cannot get to the power supply of the remote module you can attempt to connect manually using [Soft Pairing](#). Click the 'Click Here' link at the bottom of the page and follow the prompts.

The screenshot shows the 'Broadweigh Toolkit' interface. At the top left is the logo and the title 'Broadweigh Toolkit'. Below it is the 'Information' section. On the left, there is an image of a 'Broadweigh Shackle 4.75t' with a radio module attached. To the right of the image, the following information is displayed: ID: FF842E, Model: BW-S475, Firmware Version: 6.00, Radio Module Firmware Version: 4.1, Name: [redacted], Calibration Date: 20th October 2020, and Peak Value Measured: 100.0 kg. Below this is a 'Features' section with several colored buttons: 'Protected Calibration' (red), 'Supports Group Keys' (green), 'Using Group Key' (purple), 'Can Monitor Sleeping Modules' (grey), 'Extended Range/Coverage' (orange), and 'Hostile RF Adaptive' (teal). On the right side of the interface is a 'Help' section with text: 'Here you can view information about the module. You can also allocate a descriptive name to aid future identification.' At the bottom of the interface, it says 'Connected to BW-S475 of ID FF842E on channel 1' and 'App: 02.09.08 | Drv COM: 2.0 | Drv DLL: 2.7'.

Once successfully paired to a module this page is displayed showing information about the connected module. Calibration Date and Peak Value Measured will only be visible for modules that support these features.

Items you can change:

Name You can enter a short description which may help you to identify this module.

Features

Each module may support certain features which are indicated on this page. If the feature is greyed out then it is not supported. If it is coloured then it is supported.

Protected Calibration

Some transmitter modules may have had their calibration protected. This indicates that you cannot calibrate this module.

Supports Group Keys

[Group Keys](#) were introduced in 2015 so modules built before this date will not support this feature. This indicates that the connected module can support them

Using Group Key

This indicates that the connected module can support Group Keys and that one has been configured for this module

Can Monitor Sleeping Modules

Applicable to a base station only. This indicates that on the [Channel Monitor](#) page modules that are sleeping will also be listed

Extended Range/Coverage

Extended range radios were introduced to the Broadweigh range in 2015. This indicates that the connected module has an extended range radio fitted.

Hostile RF Tolerant

V4.0 radio modules introduce better performance in hostile RF environments. This includes better pairing and reception as well as battery life. V5.0 radio modules will display **Hostile RF Adaptive** as this supports Adaptive CCA Threshold functionality.

Battery and Radio Levels

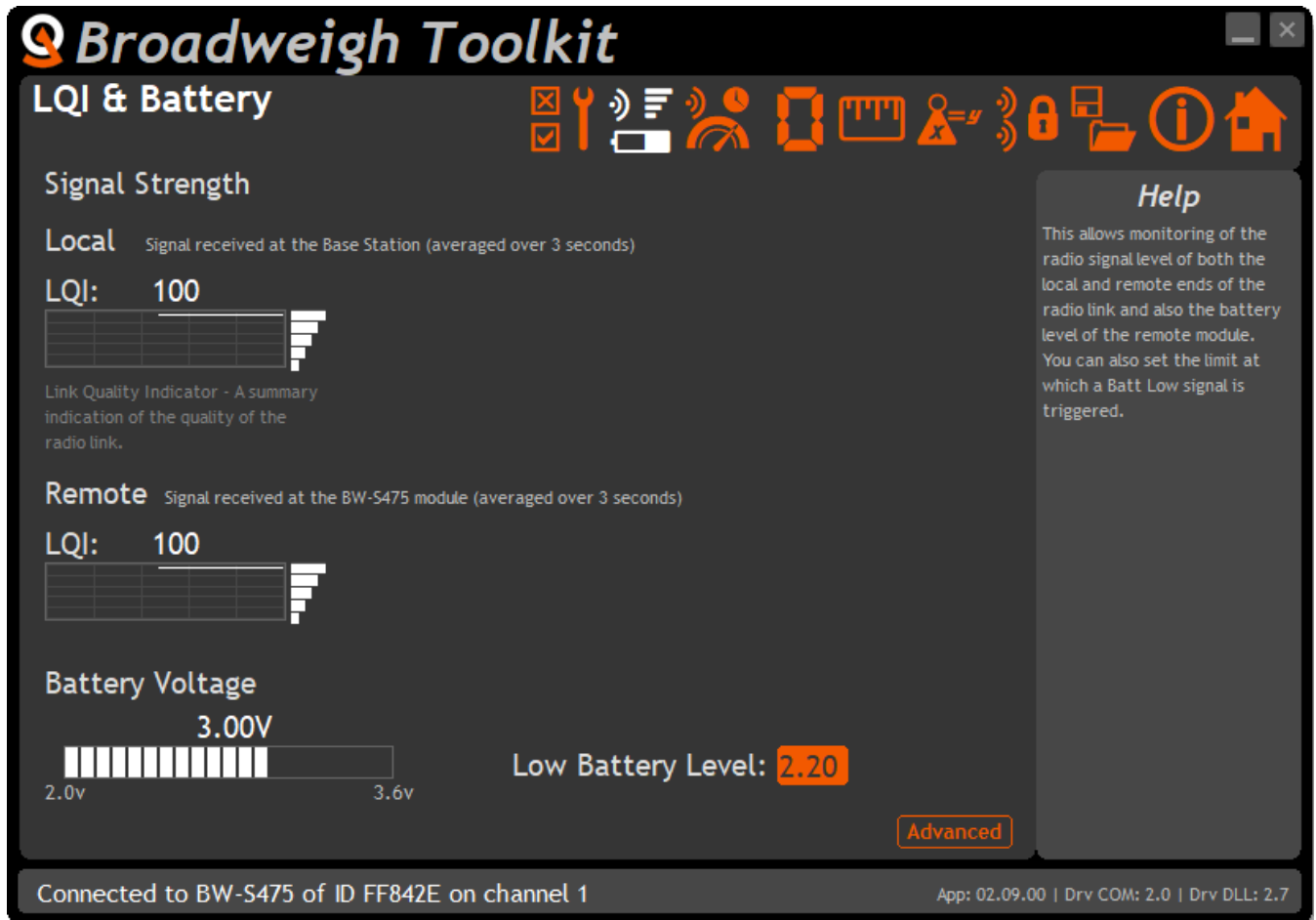

Here you can see the voltage of the battery and the radio signal levels at the base station and the remote transmitter module. This simple view gives an LQI value which stands for Link Quality Indicator. This value will range from 0 to 100 and anywhere within this band you should still achieve communications. As the level drops towards zero communications may become intermittent but still achievable.

On modules that are battery powered the battery voltage section will be visible. You can set the level at which the transmitter module reports a low battery. (At 2.1 V the module will stop working)
If the battery voltage is below the Low Battery Level the bar will be coloured orange.

Items you can change:

- | | |
|-------------------|--|
| Low Battery Level | Click this item to set the battery low level. Note: This is not displayed when shackles are used in Simple Configuration Mode. |
| Advanced Button | Clicking this will give more detailed information on the RSSI and CV levels of the received radio packets. |

Battery and Radio Levels Advanced

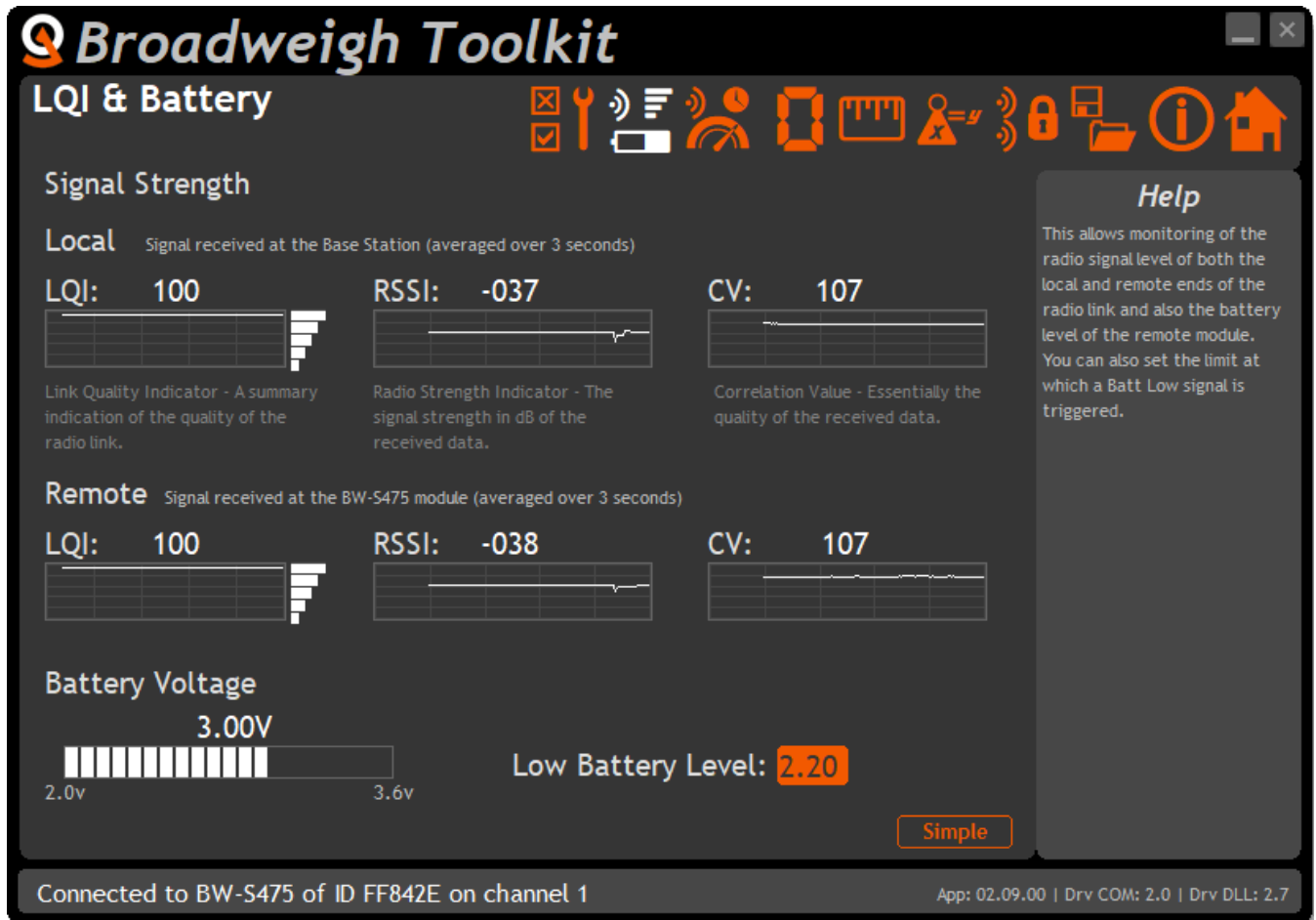

LQI value which stands for Link Quality Indicator. This value will range from 0 to 100 and within this band you should still achieve communications. As the level drops towards zero communications may become intermittent but still achievable. The LQI value is derived from the RSSI and CV values.

RSSI is the Radio Signal Strength Indicator and indicates the received dB level which will range from about -30 which is a good signal to -98 which is a weak signal.

CV is the Correlation Value and indicates how well the signal can be decoded. This ranges from 55 which is a poor quality signal and 110 which is an excellent signal.

Radio Settings

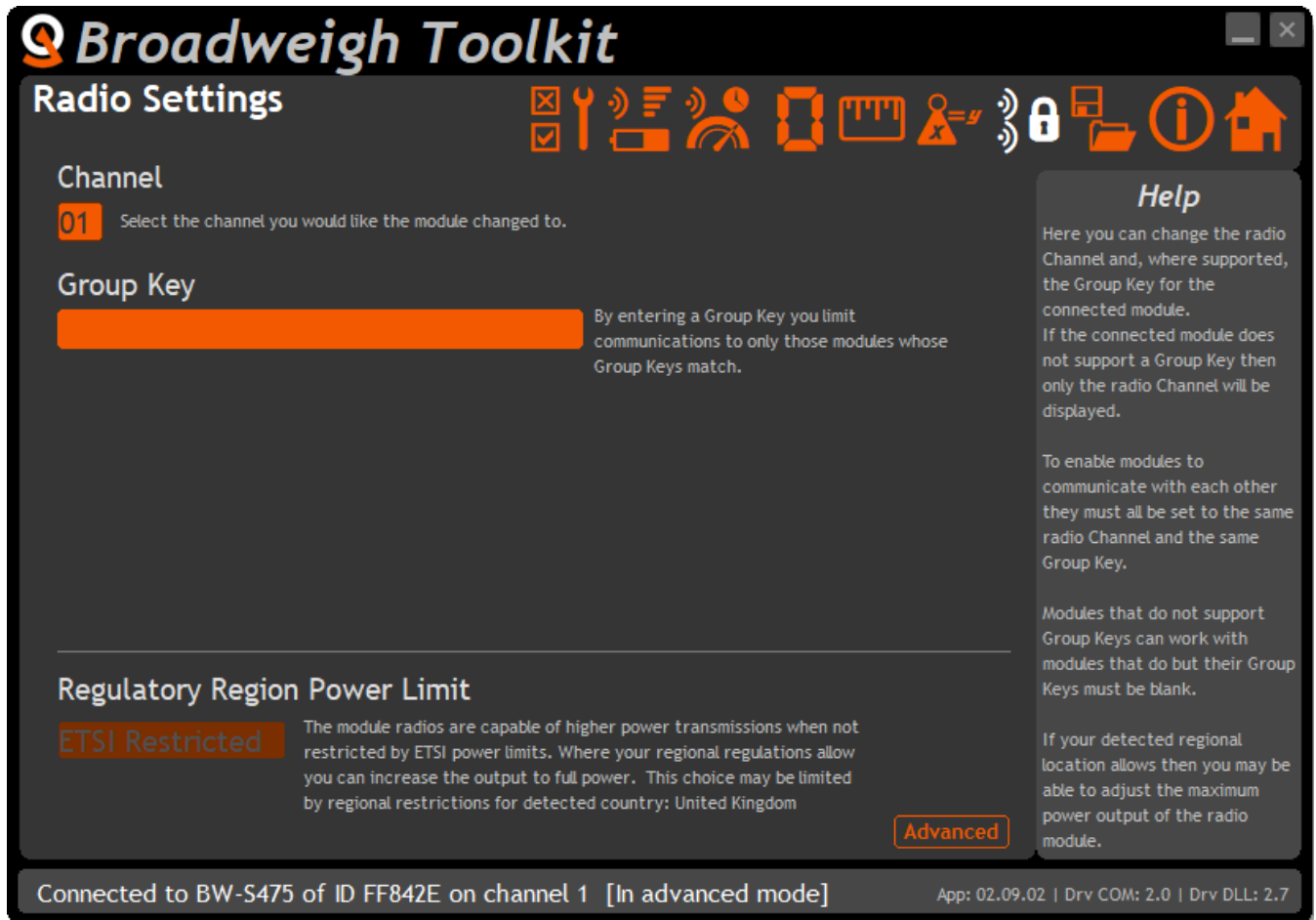

Here you can change the channel and group key for the connected module.

Items you can change:

- | | |
|-------------------------------|--|
| Channel | Select a radio channel between 1 and 15. The default is channel 1. You can use the Spectrum Analyser mode to determine a good clean channel to use. |
| Group Key | Only visible on modules that support Group Keys.
Only modules with identical group keys can communicate. This allows isolation of different groups of modules on the same channel or ensures the security of data. Early versions of Broadweigh modules do not support Group Keys and this option will not be visible in the Toolkit.
To use modules that support Group Keys with older modules that do not then the Group Keys must be blank. |
| Regulatory Region Power Limit | For devices that are used in regions where regulations allow a larger radio power output than the level set at manufacture then this section will be enabled. The default is ETSI Restricted but where allowed (such as USA and Canada) the option of Full Power will be available. |
| Advanced | This displays the Radio Settings Advanced page described below. This button is not visible when connected to a shackle in simple configuration mode. |

Radio Settings Advanced

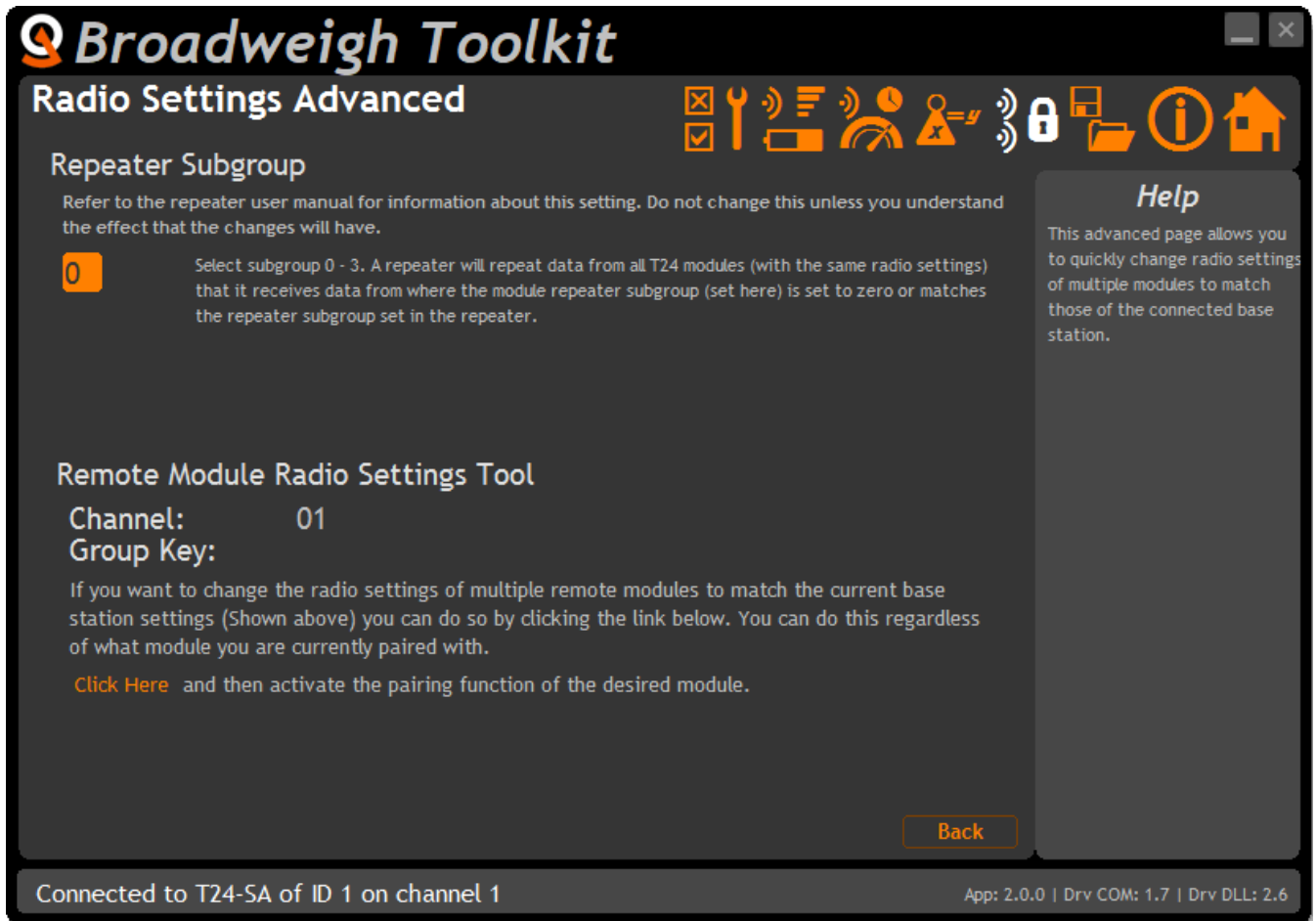

Here you can change the repeater subgroup settings for the connected module. Also a tool is provided to quickly match remote module radio settings to the base station radio settings.

Items you can change:

Repeater Subgroup

Select a repeater subgroup for this module. The default is zero which will let all repeaters repeat messages from this module. See [Repeaters and repeater Subgroups](#)

Remote Module Radio Settings Tool

To quickly set a batch of remote modules to match the radio settings of the base station you can use this tool. Usually this is arrived at by pairing with the base station by holding the shift key whilst clicking the Pair button on the [Home](#) page.

To change the remote module radio settings:

- Remove remote module power
- Click the 'Click Here' link on the page
- Apply power to the remote module

The Toolkit will remain unchanged and still paired to whatever module or base station it was paired to but the remote module will have changed its radio settings.

Save and Restore



Here you can save the module settings to a file on your PC so that they can be later loaded back into the same or different module.

Items you can change:

Save

Click this button to open a file dialog window to allow you to select a filename and location to save the configuration file to.
All configuration information including calibration data will be saved to the file.
The file extension is **tcf**.

Restore

Click this button to open a file dialog window to allow you to select a filename and location of a previously saved file to load into the connected module.
All configuration information will be overwritten.
The file extension is **tcf**.

Transmitter Modules

Broadweigh Transmitters are the modules that connect to a sensor or have an input signal applied and periodically transmit messages containing the value read from the sensor or input. These modules include shackle load cell transmitters and wind speed sensor transmitters.

BW-S325, BW-S475, BW-S475-TL, BW-TL, BW-S900

Overview

The Broadweigh Shackle is a bow shackle with integrated electronics which features the following:

- Available in 9 tonne, 4¾ tonne or 3¾ tonne options
- Up to 800 m line of sight wireless transmission range
- Fully weatherised (IP67)
- 5:1 safety factor
- Low rigging profile from 60 mm
- 2000 hr battery life at transmission 1 per second
- Smart Sleep function to preserve battery life when not needed
- Accuracy of $\pm 1\%$ of current load or 25 kg (50 kg for 9 tonne), whichever is the greater value. (When using original bobbin or TwistLink. There may be a reduction in accuracy if these are swapped.)

Order Codes

BW-S325



Load shackle with SWL of 3.25 tonnes.

BW-S475



Load shackle capable of measuring up to 4.75 tonnes.

BW-TL (Optional Part)



The TwistLink can be retrofitted to a BW-S475 giving all the benefits of the BW-S475-TL. There will be a reduction in accuracy, see specifications.

BW-S475-TL



The BW-S475-TL is a BW-S475 with a TwistLink instead of a bobbin. This variation allows a 3.25 tonne or 4.75 tonne bow shackle to be connected to the load pin without taking it all apart.

BW-S900



Load shackle capable of measuring up to 9.0 tonnes.

Orientation & Identification

The shackle pin and bow are calibrated and load tested together. It is therefore essential for the accuracy of the system that the following information is adhered to:

Each pin and bow **must** be kept as a pair and not interchanged. The bow is marked with the ID of the pin it is associated with as shown.

The pin **must** be aligned in the same orientation with the bow as it was when calibrated. The Broadweigh shackle is designed to fit together in one orientation. The ABS enclosure should be on the left hand side when viewing the etching on the bow.

The shackle **must** be used in conjunction with a bobbin or TwistLink, nut and retaining clip as shown:



If using a TwistLink, ensure that the load sensing pin is in the side of the TwistLink marked 'Sensor'.

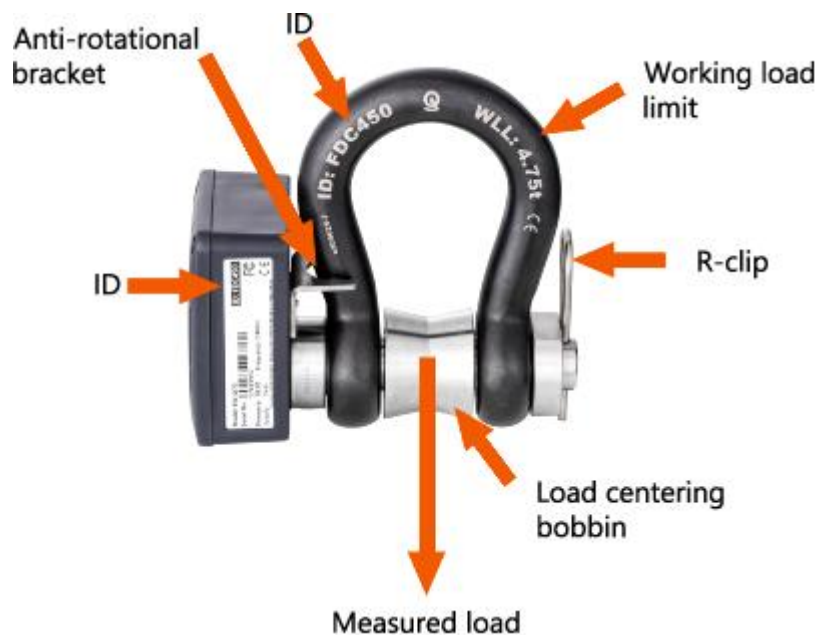

The Broadweigh Shackle is a sensitive measuring device calibrated to ensure accuracy and reliability. Care must be taken during use, transportation and storage to avoid unnecessary mechanical damage.

To ensure accuracy, load **must** be applied perpendicular to the pin and the load must be centralised with a bobbin or TwistLink.

Connections

Connecting Power

To ensure optimum battery life, only use quality alkaline batteries.

i Mantracourt Electronics recommends using Energizer® L91 Ultimate Lithium™ AA batteries. See the Energizer website for details.

<https://www.energizer.com/batteries/energizer-ultimate-lithium-batteries>

Advantages over other batteries:

- High capacity (As much as 50% more capacity than other big brand batteries).
- Wide temperature range.
- Very long shelf life.
- Leak resistant construction.

! Rechargeable batteries are not suitable.

Remove the four screws. Insert two alkaline 1.5 V AA batteries. Refit the lid.



Configuration

The Broadweigh Toolkit provides a means of simple configuration and calibration of the shackle along with useful tools to aid integration.

Launch the Broadweigh Toolkit software application and pair to this module to enable the connection to the Toolkit to allow configuration to take place. [See Common Toolkit Pages - Home](#)

From Q3 2020 all **Gen 3** shackles (with Smart Sleep support) will default to Simple Configuration Mode when connected to the Toolkit.

Users also have the ability to switch existing, older shackles into Simple Configuration Mode.

In this simple mode most of the settings for the shackles are pre-configured to settings suitable for most scenarios. Those users wishing for more control over setting can opt to convert back to Advanced Configuration Mode at any time.

Simple Mode assumes the use of the recommended **Energizer L91** batteries for the low level warnings and battery life estimations. If other batteries are used they may not last as long as the estimated battery life given. Also note that the battery low warning would be activated while there was still a lot of life left in the battery.

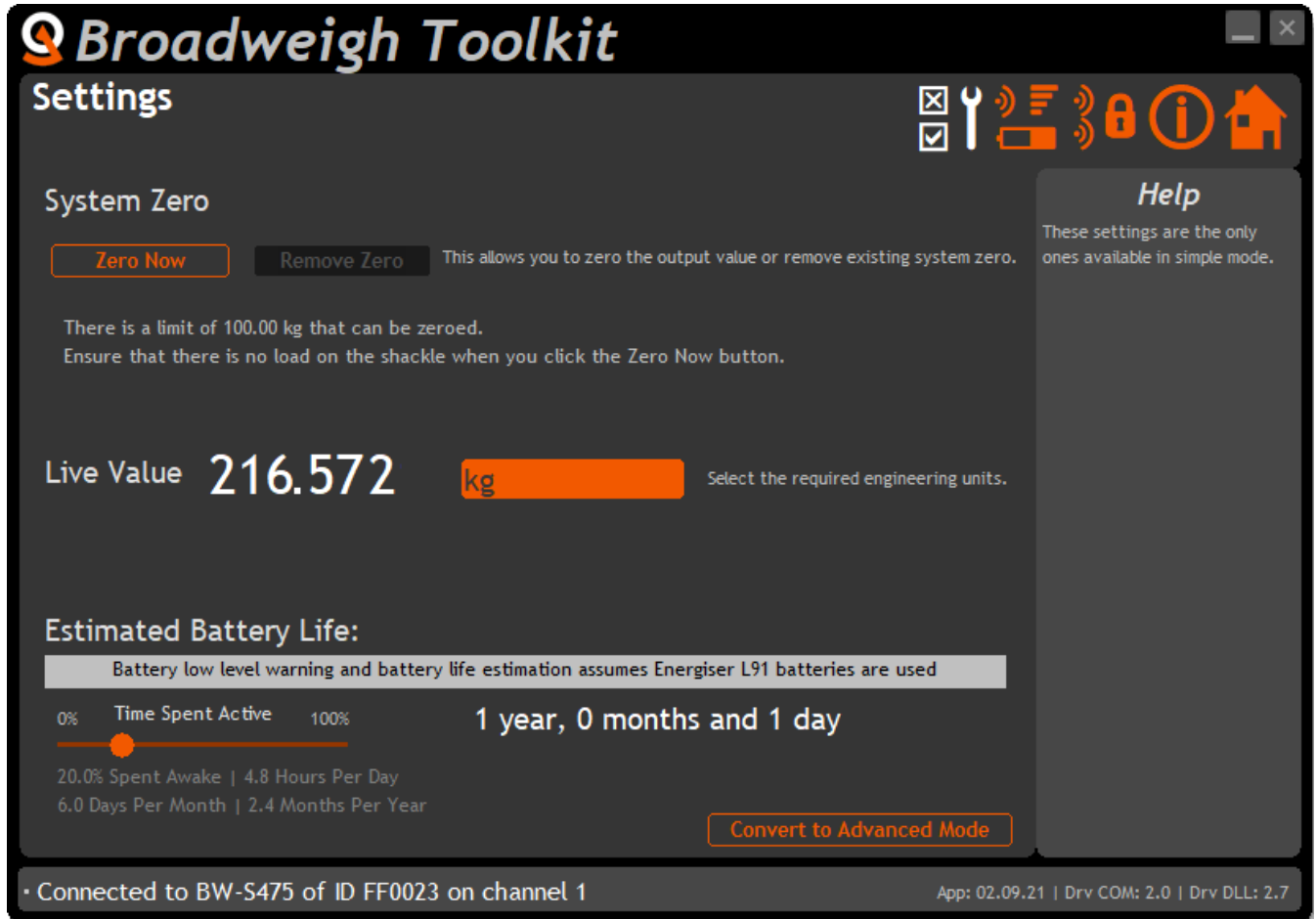

Use this page to adjust the settings of the Broadweigh Shackle.

Parameters:

Zero Now If the shackle is showing a weight value when there is no load on it click this button to set the measurement to zero.

! Do not do this directly after moving the shackle between extremes of temperature. The temperature of the pin should be allowed to stabilise for about an hour before changing the system zero.

Remove Zero Remove the current system zero to show what the shackle is measuring.
Live Value This simply displays the live value as it would be transmitted.

Units Use the drop down box to select the desired units of measurement. Choose between kg, lbs, tonnes, ton, ton (US) & kN.

i Unit selection may not be available on some shackles. When not available the units will be displayed in white text.

Estimated Battery Life This this battery life estimator to get an idea of expected battery life when using **Energizer L91** batteries. Using other types of battery may mean battery life could be as low as 60% of the life estimated. Other battery types will also cause the battery low indication to appear prematurely i.e. while there is still a lot of life left in the batteries.

Adjust the slider to represent the amount of time the shackle will be active (i.e. woken and not asleep). The label below the slider reflects the amount of time active and awake by percentage, hours per day, days per month and months per year. One of these should suit your own idea of estimated usage.

As the slider is moved the estimated battery life will be displayed to the right.

Convert to Advanced Mode Clicking this button will cause the toolkit to use Advanced Configuration Mode for this shackle where you will have many more options to configure. You can always switch back to the Simple Configuration Mode from there.

 This option may not be available on some shackles. The button will not be visible when not available. If this is the case, you will need to contact your distributor if you require advanced mode.

Managed Parameters

In simple configuration mode many parameters and settings are managed for you. Some parameters are set to certain values when you choose to use simple configuration mode and one is just hidden but not changed.

Parameters Pre-configured

These parameters are changed to the values shown below when the user switches a shackle to simple configuration mode. These are also the default values for version 6.0 shackles.

Sleep Delay = 900 seconds (15 minutes)
TX Interval = 1 second
Zero Indication Band = 5 kg
Sample Time = 5 ms
Low Power Mode = On
Battery Low Level = 2.7 V

Smart Sleep Mode = Active *On version 6.0 shackles supporting Smart Sleep*
Smart Sleep Level = 5 kg
Smart Sleep TX Interval = 10 seconds

Parameters Hidden From View

This parameter is also hidden from view in the Toolkit when simple configuration mode is selected but the values will remain as they are set before entering the mode. The factory default for the Data Tag is the last 4 characters of the hexadecimal ID.

Data Tag

Advanced Configuration Mode

In this mode all of the available parameters and settings for the shackle are available to change.

Units



Use this page to select the Output units of the Paired Broadweigh Shackle.

Parameters:

Output Units Use the drop down box to select between kg, lbs, tonnes, ton, ton (US) & kN.



If these units are changed ensure the Zero Indication Band and Smart Sleep Level are also set correctly.

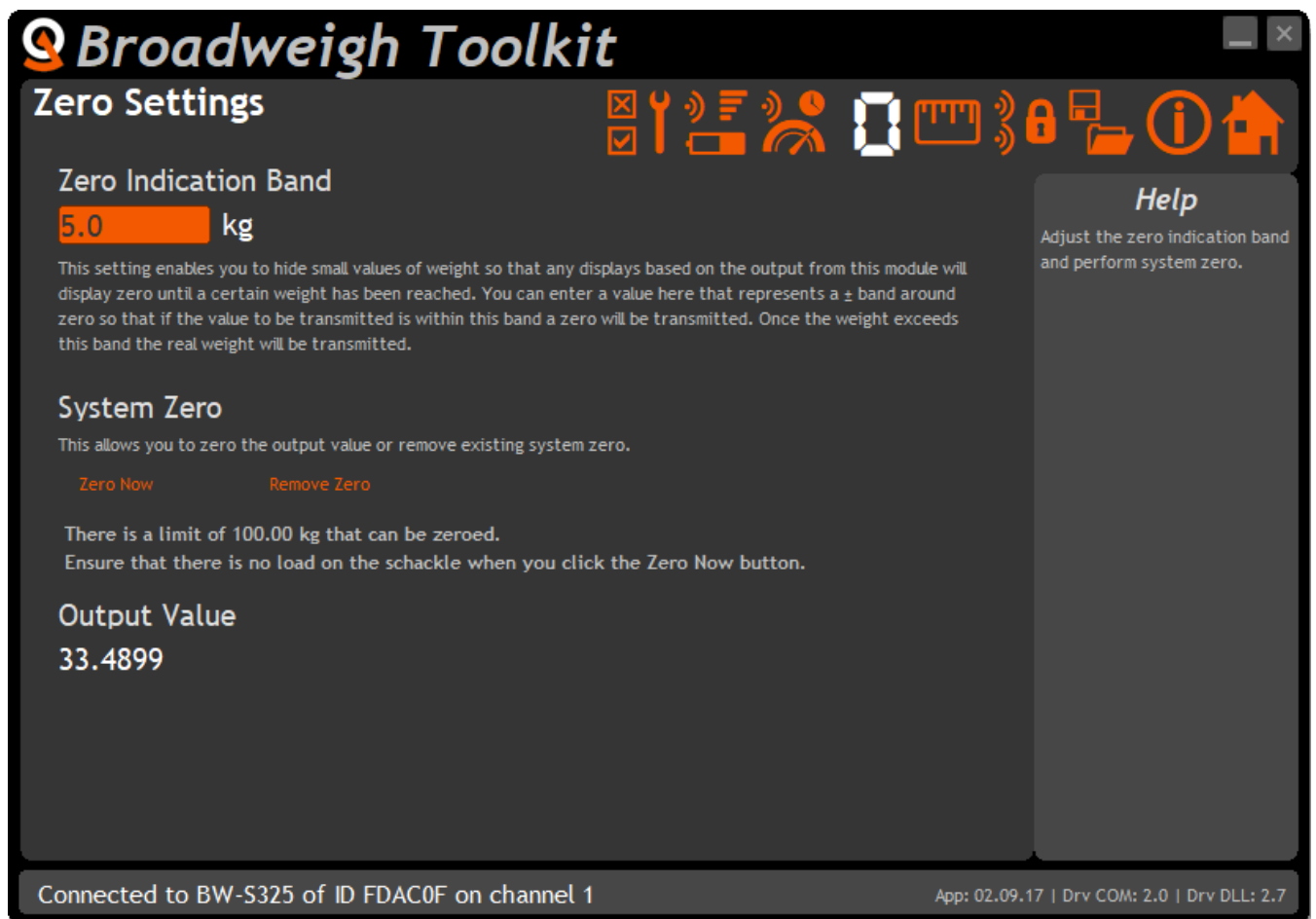

Use this page to perform system zero and to hide small values of weight (masking) for the paired Broadweigh Shackle

Parameters:

Zero Indication Band	<p>This setting enables you to hide small values of weight so that any displays based on the output from this module will display zero until a certain weight has been reached. You can enter a value here that represents a \pm band around zero so that if the value to be transmitted is within this band a zero will be transmitted. Once the weight exceeds this band the full weight will be transmitted.</p> <p>For example: A Broadweigh Shackle with a 5.0 kg Zero Indication Band will only transmit a zero value until 5 kg of weight or more is applied when it will then transmit the applied weight value.</p> <p>If you change the module units you will need to adjust the zero indication band again.</p>
System Zero	<p>If the unloaded shackle is displaying a small weight you can re-zero the output value by applying a system zero.</p> <p>Remove the load from the shackle before clicking the 'Zero Now' button.</p>
Output Value	<p>This shows the weight value that will be transmitted and shows the effect of the system zero and the zero indication band.</p>

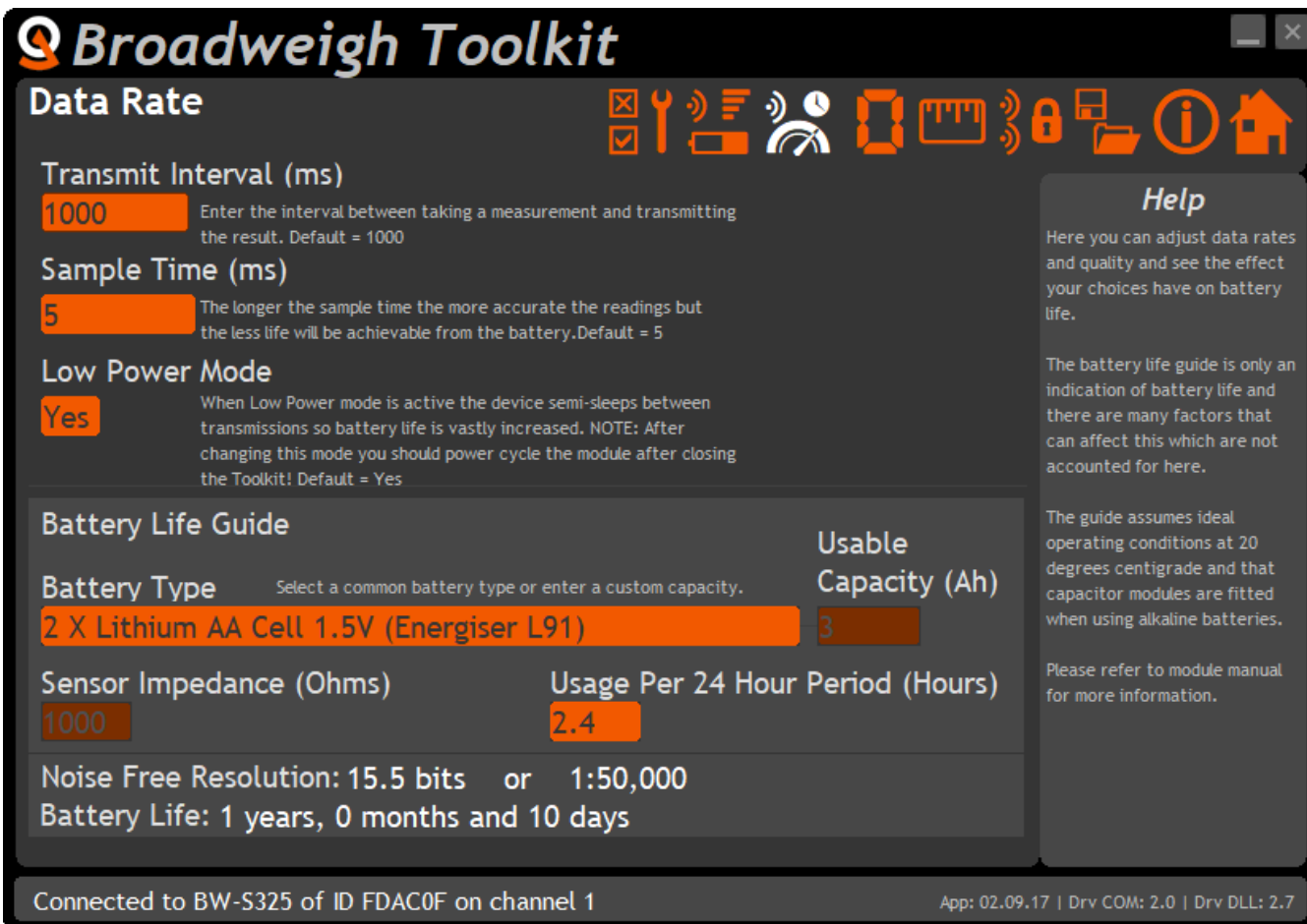

Use this page to select the rate at which data is transmitted from the acquisition module and the quality. By selecting low power mode and entering some other information the toolkit will also give guides on achievable battery life. Note that the battery life guide assumes a 20°C ambient temperature. To ensure optimum battery life, only quality alkaline batteries are recommended. *Rechargeable batteries are not suitable.*

Parameters:

- Transmit Interval** Enter the transmission rate in milliseconds. The default is 1000 ms for Broadweigh Shackles.
 Longer battery life will be achieved with less frequent transmissions.
- Sample Time** This is the length of time in milliseconds that the input is sampled before the value is transmitted. This can vary between 5 ms and close to the Transmit Interval. A shorter sample time means that the device is awake for less time so battery life is increased but at the expense of a reading with less noise free resolution. Alter this to see the effect on battery life and noise free resolution.
- Low Power Mode** Low power mode is the usual mode of operation and increases battery life. If the transmission interval were increased above 25 Hz (40 ms transmit interval) then low power mode would need to be turned off.

Continued...

Battery Type	This is not a parameter of the device but information used by the battery life guide. Choose from some pre-set battery parameters or choose custom and select chosen battery capacity. See below. This will also offer to change the Battery Low Level if the level suitable for the chosen battery is not the level currently set.
Usable Capacity	This is not a parameter of the device but information used by the battery life guide. This is the capacity of the battery in amp hours and has a profound effect on battery life calculations. This capacity needs to be calculated from battery manufacturer's data sheets to take into account that you can only use batteries down to 2.1 volts so in the case of twin AA cells this would be 1.05 volts. Generally the usable capacity will not be as high as that advertised by the battery manufacturer. Temperature and internal resistance of the battery are not taken into account in the guide.
Sensor Resistance	This is fixed at 1000 ohms.
Usage Per 24 Hour Period	In order to estimate battery life, enter the number of hours per 24-hour period that the Broadweigh Shackle will be connected to a Broadweigh USB base station or Handheld remote

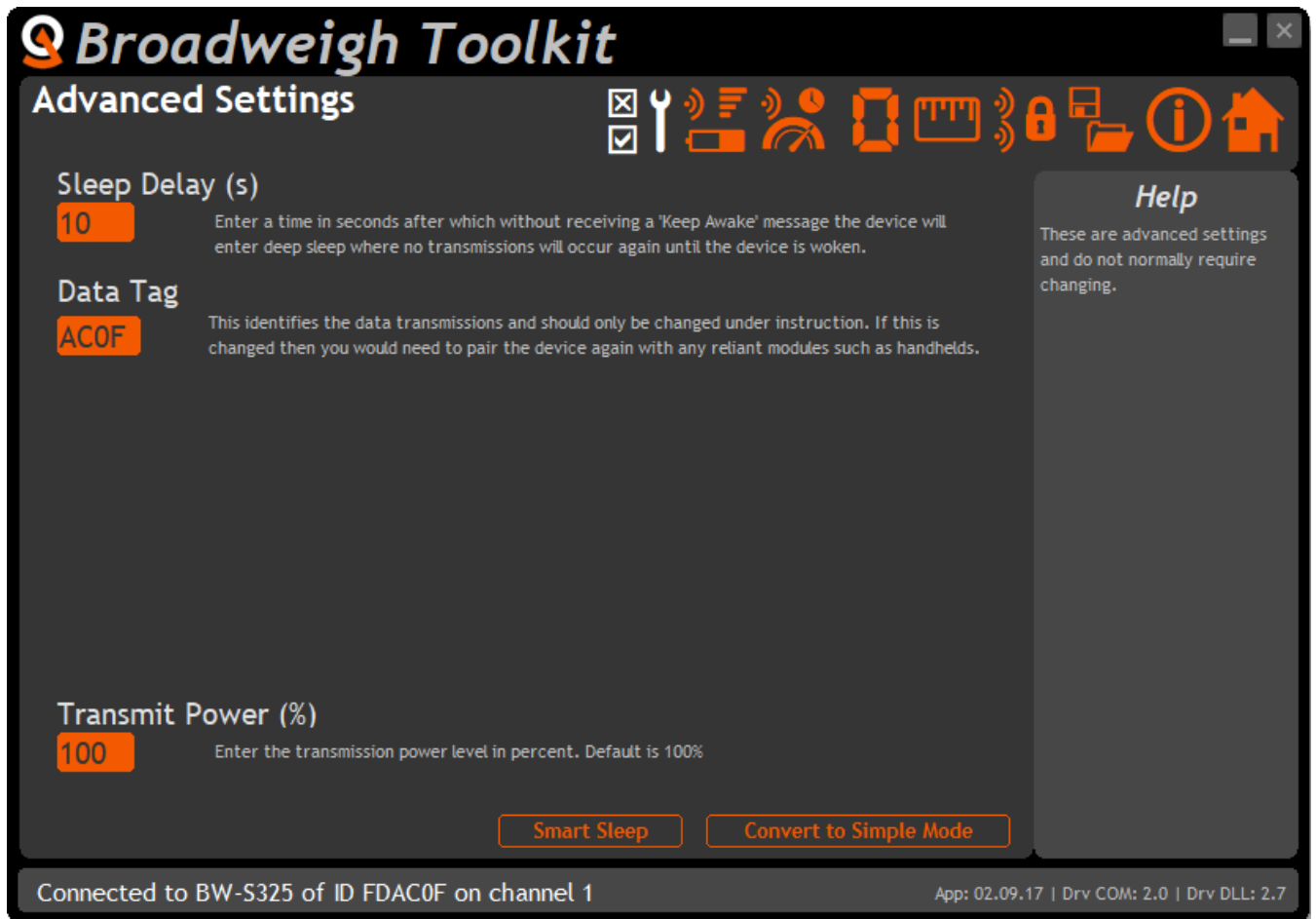

It should not normally be necessary to change these settings.

Parameters:

Sleep Delay Enter a delay in seconds after which the Broadweigh Device will return to deep sleep if no Keep Awake message is heard from the handheld or base station. The default is 60 seconds.

i If a value of 0 is used the shackle will not enter into low power state and battery life could be compromised if no other device sends the shackle to sleep.

Data Tag The data transmitted by the Broadweigh Shackle is marked with a Data Tag. By default this is set to the last 4 characters of the device ID. The Broadweigh Shackle Data Tag can be changed to an easily remembered 4 digit code to reflect its position within your system. For example '00A1'.

Smart Sleep This is only available on firmware version 6.0 shackles. Clicking this button allows you to configure Smart Sleep. See next section.

Convert to Simple Mode This will switch back to using Simple Configuration Mode for the connected shackle. See [Simple Configuration Mode](#).

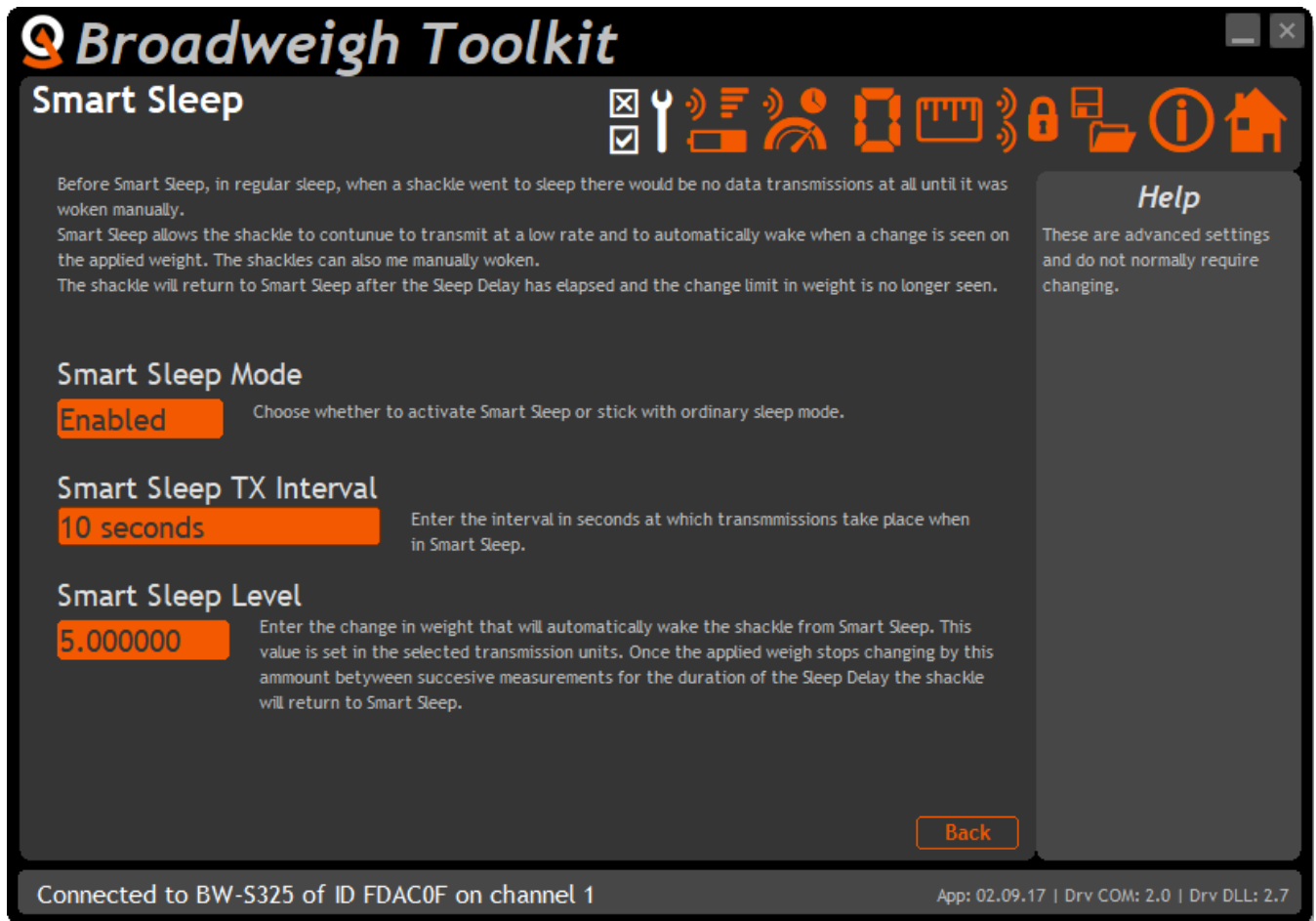

In **Gen 3** shackles Smart Sleep was introduced and replaces the standard Sleep. Unlike standard Sleep mode, Smart Sleep adds two important features.

Transmissions still take place at a new reduced rate. This defaults to a transmission every 10 seconds. In some cases this is a good enough rate for the system to operate at permanently so the shackles need never be woken (Where they would transmit at a faster rate which is every second by default).

The second feature is that the shackles can automatically wake when the weight changes thus automatically providing data at a faster rate when changes to the load have occurred and so the data becomes more interesting.

Newer shackles with these features can be made to operate just like before by setting the **Smart Sleep Mode** to **Disabled**.

Parameters:

- Smart Sleep Mode Select either Enabled or Disabled. When disabled the shackle will sleep in the usual manner.

- Smart Sleep TX Interval When smart sleep is enabled a measurement will still be taken and the value transmitted at the specified interval. The default is every 10 seconds.

- Smart Sleep Level If the measured weight changes by this amount or more between successive measurements then the shackle will wake and transmit at its faster TX Interval rate. Enter a level of zero to disable this feature.

Enclosure & Mounting

Dimensions

BW-S325

(Nominal, mm)

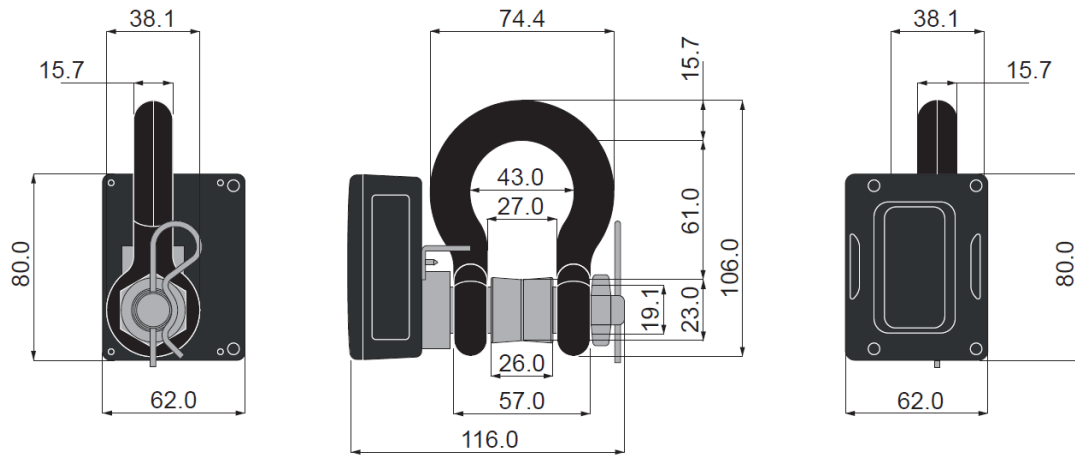

BW-S475

(nominal, mm)

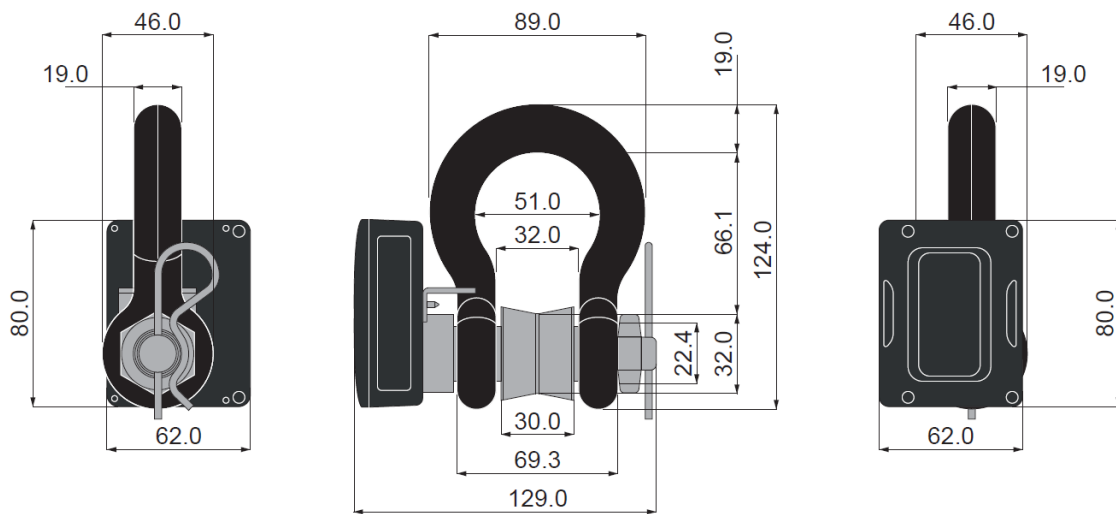

BW-S475-TL

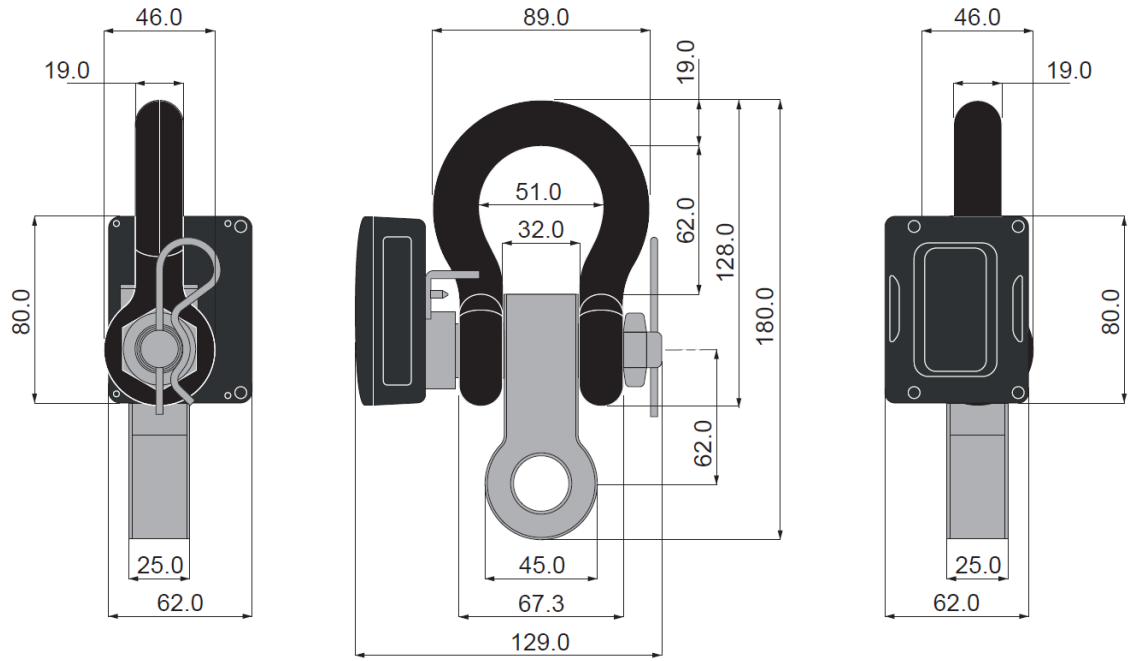

BW-S900

(Nominal, mm)

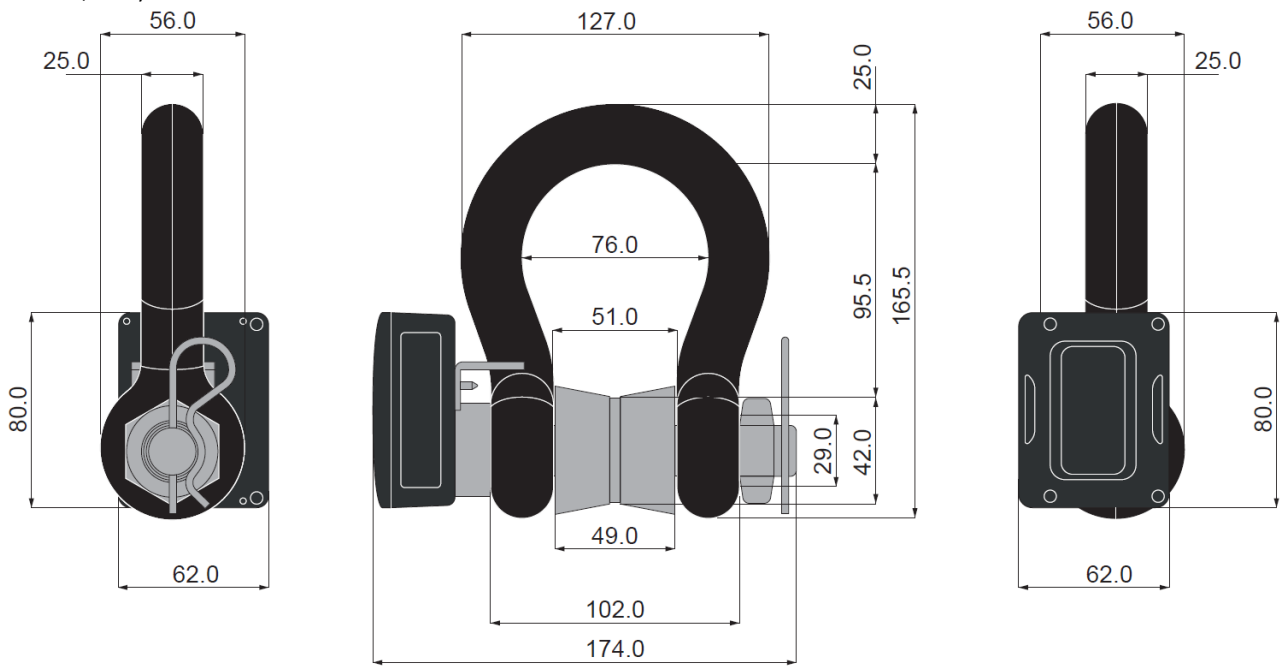

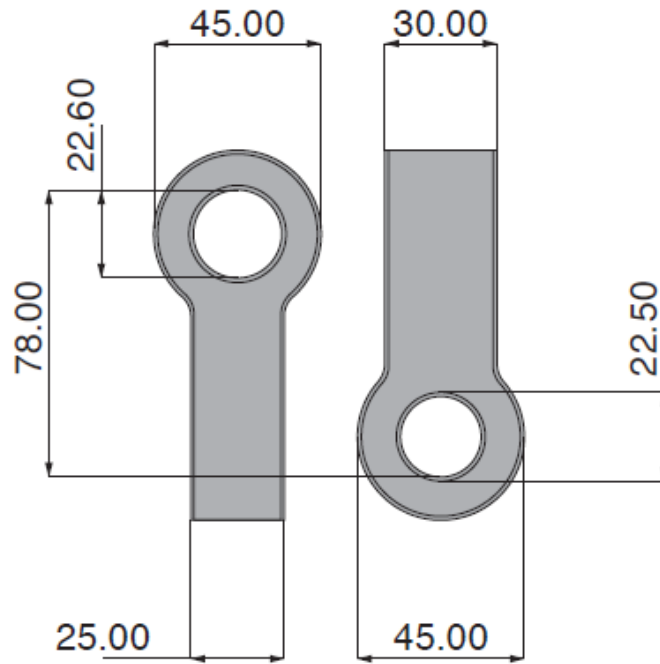

Opening the Case

Remove the four screws, see [Connecting Power](#)

LED Indicator

The Broadway Shackle is fitted with an LED to provide a visual indication of data transmission from the acquisition module inside. The LED flashes whenever a data transmission occurs. Modules are pre-configured to provide readings once per second.

<i>Flashing</i>	Data transmitting
<i>Constant</i>	Connected to Broadweigh Toolkit or handheld display for configuration
<i>Off</i>	Asleep

Specification

Measurement	Min	Typical	Max	Units
Working Load Limit (WLL)				kg
BW-S325			3250	
BW-S475			4750	
BW-TL			4750	
BW-S475-TL			4750	
BW-S900			9000	
Accuracy Original Bobbin/Twistlink BW-S325/BW-S475(-TL) BW-S900		Typically $\pm 1\%$ of load or ± 25 kg whichever is greater Typically $\pm 1\%$ of load or ± 50 kg whichever is greater		
Accuracy After Replacing Original Bobbin with Non Original Bobbin		Typically $\pm 2\%$ of load or ± 35 kg whichever is greater		
Accuracy After Replacing Original Bobbin with Twistlink (BW-TL)		Typically $\pm 2.5\%$ of load or ± 50 kg whichever is greater		

Power Supply	Min	Typical	Max	Units
Estimated Battery life 2 X AA Energizer L91 batteries (1 update per second when awake and 10 second Smart Sleep):				
Asleep		2.5+		Years
Continuous operation		3		Months
8 Hours Usage Per Day		8		Months
4 Hours Usage Per Day		1.0		Year
2 Hours Usage Per Day		1.5		Years

Environmental	Min	Typical	Max	Units
IP rating		IP67		
Operating temperature range	-20		+50	$^{\circ}\text{C}$
Storage temperature*	-40		+85	$^{\circ}\text{C}$
Humidity	0		95	%RH

* Excludes Batteries.

Radio Range

For details of radio range please refer to [Appendix B – Radio Range](#)

BW-WSS

Overview

The BW-WSS wireless anemometer is built on the same technology as other Broadweigh wireless sensor interfaces offering the same sleep and wake functionality and operation with peripheral modules including handhelds and USB base stations.

The Anemometer features a high quality 3-cup rotor pressed on a stainless steel shaft with rugged Delrin body with bronze Rulon bushings

The output value of the anemometer can be configured to the user's requirements and measure over the range 5 to 125 mph.

Accuracy:

- 0.5 mph from 5 to 10 mph
- $\pm 4\%$ from 10 to 125 mph

The user can set a period over which to average the wind speed (regardless of transmission rate) and optionally include a second transmission of gust which is also measured over a user defined period.

The BW-WSS is powered either from internal batteries or an external supply. For applications which require high sampling rates for long periods Broadweigh's PowerPack and SolarPanel ([PP1 & SP1](#)) offers an ideal solution.

Order Codes

BW-WSS



Wireless wind speed transmitter module mounted in large weatherproof enclosure with battery holder for two D cell alkaline batteries. Also has ability to be powered from external supply voltage. For clamp mounting to 50 mm scaffold pole.

Connections

Power

Power can be supplied by fitting two D cell alkaline 1.5 V batteries or the module can be supplied from an external 5 Vdc to 18 Vdc source. The module will switch to the external supply in preference providing a battery backup. In both cases you need to fit the JP1 power jumper to supply power to the transmitter module. When powered from the external DC source the LED will illuminate. The cable for the external supply should be routed into the cable gland at the bottom of the case, up past the battery holder and into the two part connector terminals shows in the diagram below.

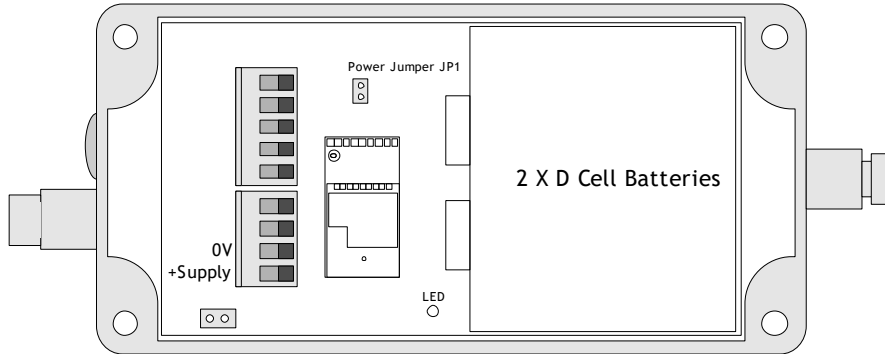

Configuration

The Broadweigh Toolkit provides a means of simple configuration and calibration of the transmitter module along with useful tools to aid integration.

Launch the Broadweigh Toolkit software application and pair to this module to enable the connection to the Toolkit to allow configuration to take place. [See Common Toolkit Pages - Home](#)

Data Rates and Quality

The screenshot shows the Broadweigh Toolkit software interface. The main window has a dark theme with orange accents. At the top left is the logo and title 'Broadweigh Toolkit'. Below it is a 'Data Rate' section with several settings: 'Transmit Interval (ms)' set to 1000, 'Average Sample Period (s)' set to 10, and 'Gust Sample Period (Optionally transmitted on F693 Data Tag)' set to 'Disabled'. There is also a 'Low Power Mode' section set to 'Yes'. Below these is a 'Battery Life Guide' section with 'Battery Type' set to '2 X Alkaline D Cell 1.5V (Duracell LR20)' and 'Usable Capacity (Ah)' set to 10. The 'Usage Per 24 Hour Period (Hours)' is set to 24, resulting in a 'Battery Life: 1 years, 2 months and 16 days'. A 'Help' sidebar on the right provides additional information. At the bottom, it shows 'Connected to BW-WSS of ID FEF692 on channel 1' and version information: 'App: 2.5.15 | Drv COM: 2.0 | Drv DLL: 2.7'.

This page allows you to select the rate at which data is transmitted from the transmitter module and the quality. By selecting low power mode and entering some other information the toolkit will also give guides on achievable battery life. Note that the battery life calculator is assuming the best case scenario which is at 20 °C and that the battery has a suitable low internal resistance or that a suitable capacitor is fitted across the battery. See battery details in the Installation section.

Items you can change:

- | | |
|---------------------------|--|
| Transmit Interval | Enter the transmission interval in milliseconds. The default is 1000 giving a reading every second. You may want increase this value to slow transmissions down to achieve longer battery life. |
| Average Sample Period (s) | The average wind speed as measured over the sample period defined here is transmitted every Transmit Interval using the Data Tag set in the Advanced Settings. This period is a moving window so at every transmission interval the value transmitted will be the average wind speed as measured over the last sample period up to the transmission event. If the sample period is set to less than the transmit interval then the value transmitted will actually be the average of the wind speed since the last transmission. So setting this to zero would always transmit the average wind speed between transmissions. |

Gust Sample Period (s)

The gust value is transmitted at the transmit interval using the Data Tag + 1. The Data Tag used will be displayed in the title.

 Note that the Data Tags are represented as hexadecimal values so adding 1 to the base Data Tag may not result in an obvious new Data Tag. After digits 0-9 come letters A-F.

Base Data Tag	Gust Data Tag
F123	F124
F129	F12A
F1AF	F1B0

The wind speed gust value is optional and can be selected by choosing a gust sample period from **Disabled, 1, 3, 5** or **10 seconds**.

The gust value transmitted is the maximum average wind speed measured within the rolling window as defined by the gust sample period.

For example, the transmit interval may be 30 seconds and the gust sample period may be 5 seconds so that every 30 seconds the gust value transmitted would be the **maximum** average wind speed seen within **any** 5 second period since the previous transmission.

Low Power Mode

Unless the transmitter module is non battery powered this should be set to Yes. In between transmissions the transmitter module will enter low power mode which will have a large effect on battery life. A Reason for **not** using Low Power Mode would be if using the module in a Master-Slave arrangement with PC for example.

Battery Type

This is not a parameter of the module but information used by the battery life guide. You can choose from some preset batteries or choose custom to allow you to select your own battery capacity. See below. This will also offer to change the Battery Low Level if the level suitable for the chosen battery is not the level currently set.

Usable Capacity

This is not a parameter of the module but information used by the battery life guide. This is the capacity of the battery in Amp Hours and has a profound effect on battery life calculations. This capacity needs to be calculated from battery manufacturer's data sheets to take into account that you can only use batteries down to 2.1 volts so in the case of twin AA cells this would be 1.05 volts. Generally the usable capacity will not be as high as that advertised by the battery manufacturer. Temperature and internal resistance of the battery are not taken into account in the guide.

Usage Per 24 Hour Period

Enter the number of hours per 24 hour period that the module will be turned on and transmitting.

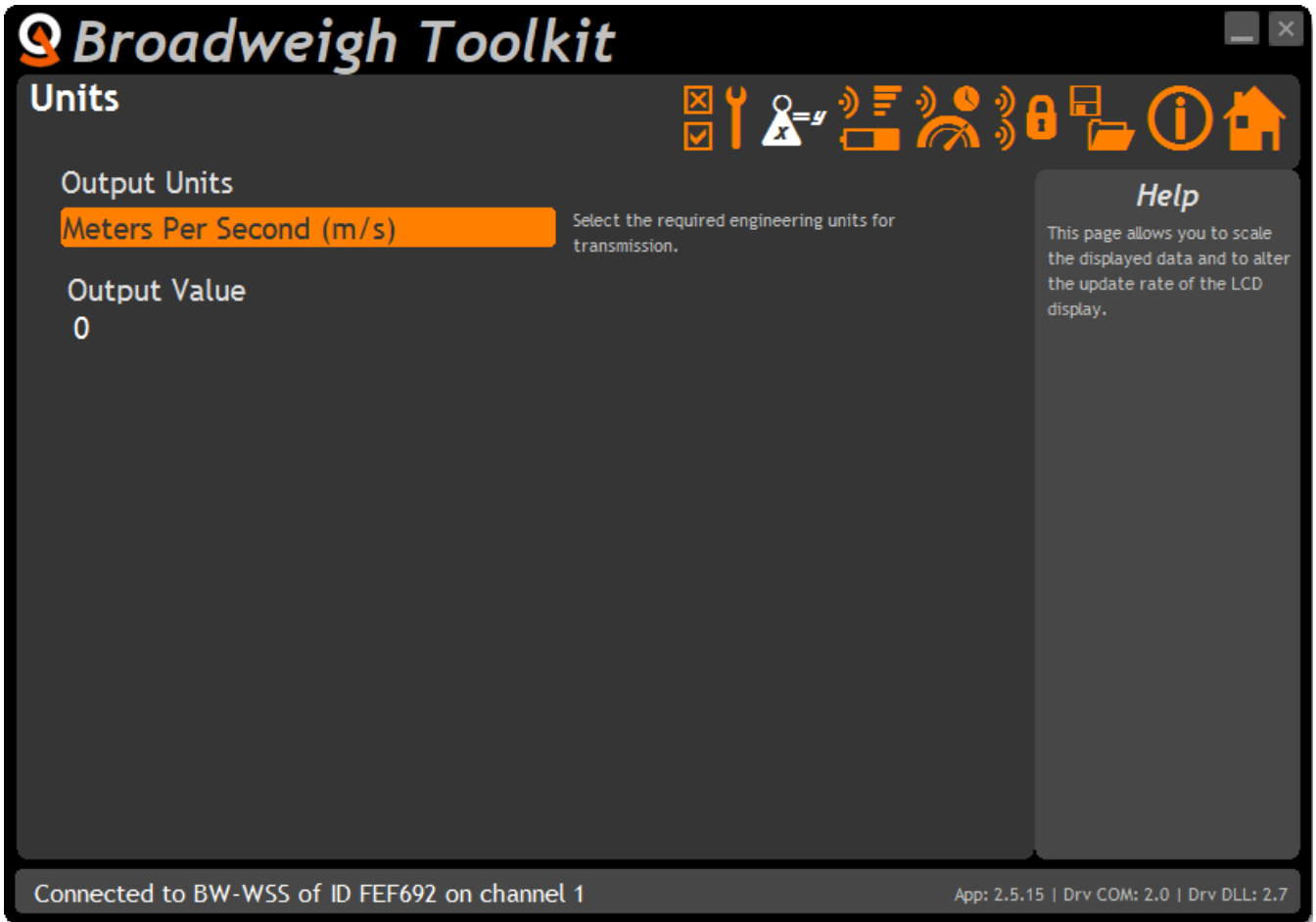

Output Value is the live value of the current wind speed in the units selected above.

Items you can change:

Output Units

Simply select the required output units from the drop down list. The BW-WSS can provide wind speed in:

Description	Units
Miles Per Hour	mph
Metres Per Second	m/s
Kilometres Per Hour	Km/h
Feet Per Second	fps
Knots	kn

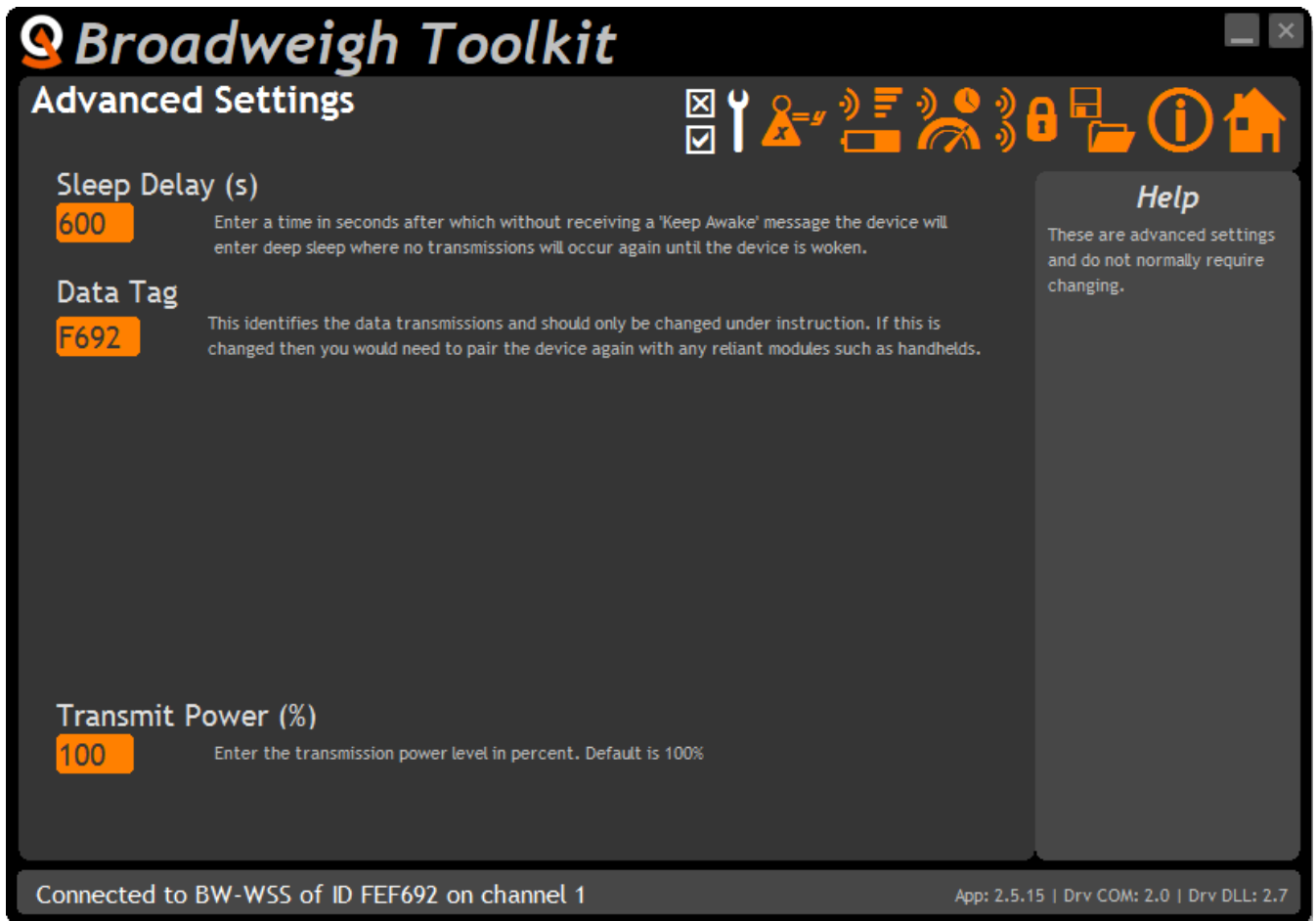

You should not normally need to change these settings.

Items you can change:

- | | |
|----------------|--|
| Sleep Delay | Here you can enter a delay in seconds after which the transmitter module will return to deep sleep if no Keep Awake message is heard from software, handheld or other receiving modules. The default is 60 seconds. |
| Data Tag | The data transmitted by the transmitter module is marked with a Data Tag which is a 2 byte hexadecimal code. By default this is set to the last 2 bytes of the module ID (or to put it another way, the last 4 characters of the module ID).
If by some chance you had two transmitter modules that would be working on the same channel and had the same last 4 characters in their ID (1 in 65535 chances) you may want to change the Data Tag of one of the modules and perform pairing again with the handheld.
Average Wind Speed is transmitted using the defined Data tag.
Optionally Gust Wind Speed is transmitted using the defined Data Tag + 1. |
| Transmit power | Set the transmit power level from 0–100%. Default is 100% |

Enclosure & Mounting

The BW-WSS is designed to be attached to the top of a 50 mm scaffold pole or equivalent using the fitted clamp.

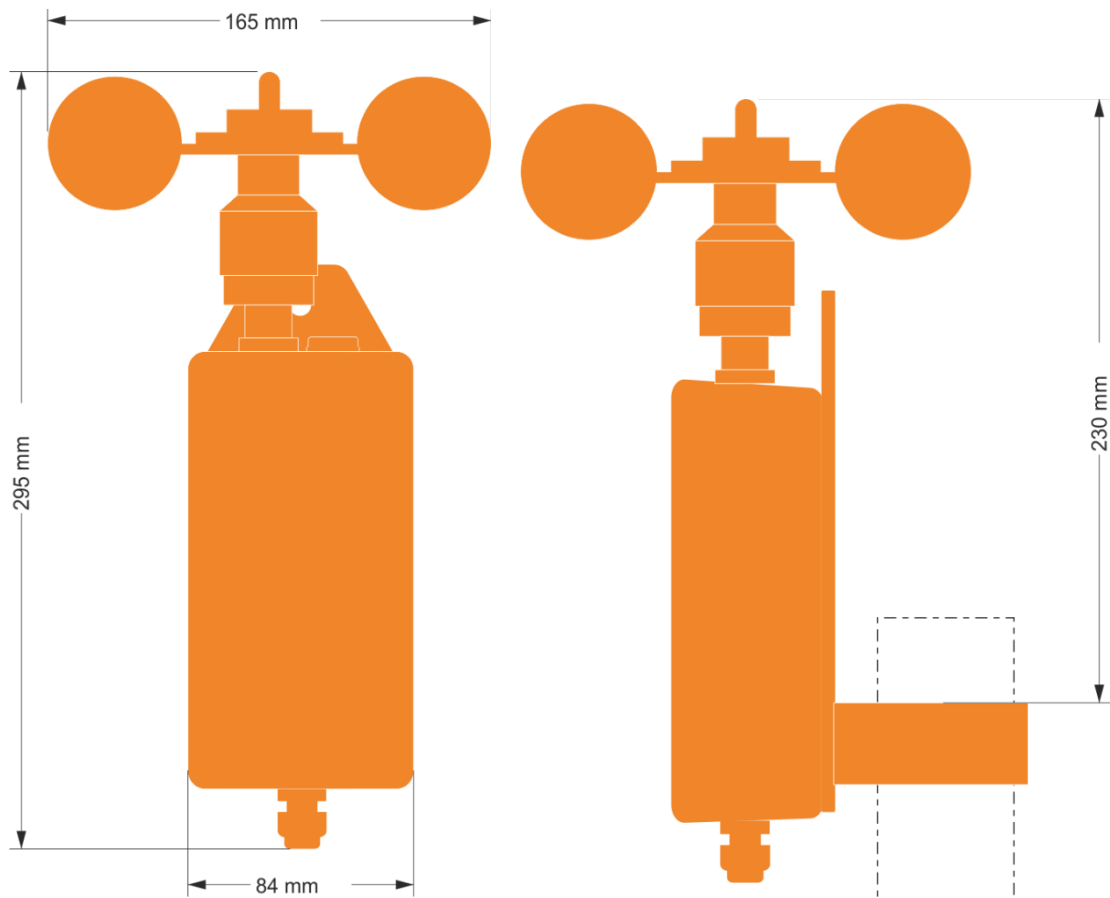

Antennas

These modules have the antenna already fitted inside the enclosure so there are no specific mounting requirements.

Specification

Specification at 3V supply at 25°C

Parameter	Min	Typical	Max	Units
Measurement Range	5	-	125	mph
Accuracy 5 – 10 mph		0.5		mph
Accuracy 10 – 125 mph		±4%		mph

Environmental	Min	Typical	Max	Units
Operating Temperature Range	-20		+55	°C
Storage Temperature	-40		+85	°C
Humidity	0		95	%RH
Environmental protection with suitable cables exiting through cable glands.		IP67		

Power Supply	Min	Typical	Max	Units
Standby / Low Power Mode		5	20	µA
Normal Mode on constantly		55	60	mA
Reverse Polarity Protection		-	-32	Vdc
Internal				
Battery Supply Voltage	2.1	3	3.6	Vdc
Current		60	65	mA (1)
External				
Power Supply voltage	5		18	Vdc
Power Supply ripple			50	mV ac pk-pk
Current		60	65	mA (1)

1. Power supply must be capable of supplying 300 mA for 250 µs

Battery Life in Low Power Mode Generating Results every second	Usage	Battery Life
Pair D cells	Constantly on	1 year
Pair D cells	12 sessions per day of 10 minutes	6 years

Radio Range

For details of radio range please refer to [Appendix B – Radio Range](#)

Receiver Modules

Receiver modules use the messages sent by the transmitter modules. These modules may process or display this information or convert the data into a different physical format.

BW-HK-S

Overview

The BW-HK-S is an IP67 rated, intuitive handheld display for viewing data from all Broadweigh transmitters. Out of the box it comes in a roaming mode. It will display data from the first twelve Broadweigh transmitters that it receives.

Alternately, up to twelve inputs can be defined, with different settings such as overload and calibrated units applied to each one.

Setup can be achieved using just the handheld, including pulling transmitters to the same radio settings. More complex setup can be achieved using the toolkit software and a USB connection.

Out of the box, some functionality is hidden for simplicity but it is possible to unlock all of the menu system using the default password or the toolkit.

Order Code

BW-HK-S



Handheld display for use with up to 12 Broadweigh transmitters in a robust weatherproof enclosure.

Connections

Power

The handheld module is powered by two alkaline AA batteries.

For battery information please refer to [Appendix D – Battery Selection](#)



Due to the higher voltage requirements of this module NiMh and NiCad batteries are not recommended.

User Operation

Keypad

The keypad has some functionality that is fixed and some that can be configured and some that changes depending on what is on the LCD display. The handheld can optionally sound a beep when keys are pressed.



Key	Function
	The top right key doubles as the power key. Hold this for approximately two seconds to turn the handheld on or off.
	The three keys along the top of the keypad are soft keys and relate to the three descriptions shown directly above them on the LCD display. The action of these keys will depend on what is currently being viewed.
	<p>The navigation keys are used for various purposes such as scrolling through available inputs, moving between displays, navigating the menu system or editing string and numeric values.</p> <p>The MENU/OK key is used to open the menu (If that has been allowed in the configuration) and to select menu items and complete editing sessions.</p> <p>Later we will explain how to use the keys to navigate the menu system.</p>
	When not in a menu the Up/Down keys can scroll through the available inputs. This could be disabled in the toolkit
	<p>When not in a menu the Left/Right keys can cycle through the available displays.</p> <p>A long press on these keys will increase/decrease the number of decimal places being displayed for the current selected units. These settings can be disabled in the toolkit.</p> <p>When in a menu the Left key performs the same function as the Back soft key and the Right key performs the same as the OK key.</p>
	<p>The MENU/OK key is used to open the menu (If that has been allowed in the configuration) and to select menu items and complete editing sessions.</p> <p>The OK key can also be held down for a long press (Approx one second then released) to cancel any current editing of values and data.</p>

Display

The BW-HK-S has a 128 x 64 monochrome dot matrix backlit display with several different display modes. As standard these will be List, Detail and Radio and are detailed below. However, some of them could have been disabled in the toolkit.

Display Modes

Cycling through the available displays is achieved using the left and right keys. Scrolling through the available inputs is achieved using the up and down keys.

The different displays may also have different soft key functions.

List- Roaming

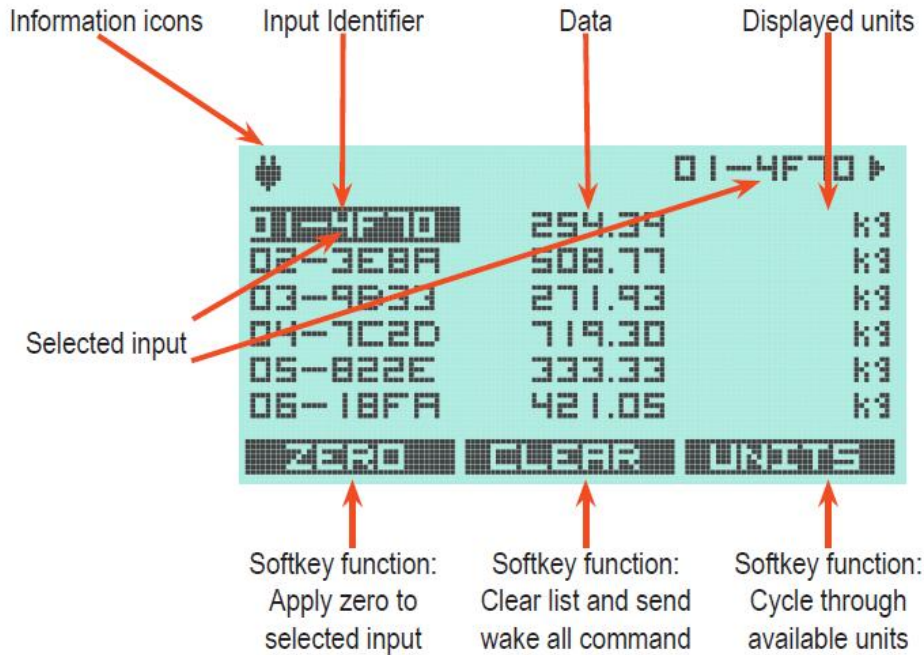

The List display shows live data from up to six inputs at once (12 are available with scrolling).

In roaming mode the first column will show the input number and the data tag of the incoming data. The second column shows the data and the third is the selected units. The selected input is highlighted and shown in the top right corner.

Softkey 1 applies a zero to the selected input or returns to the gross value.

Softkey 2 clears the list and sends a wake all command to allow different transmitters to be displayed.

Softkey 3 cycles through the available measurement units.

The up and down keys scroll through the available inputs.

The left key displays the Radio display. The right key displays the Detail display.

List-Defined

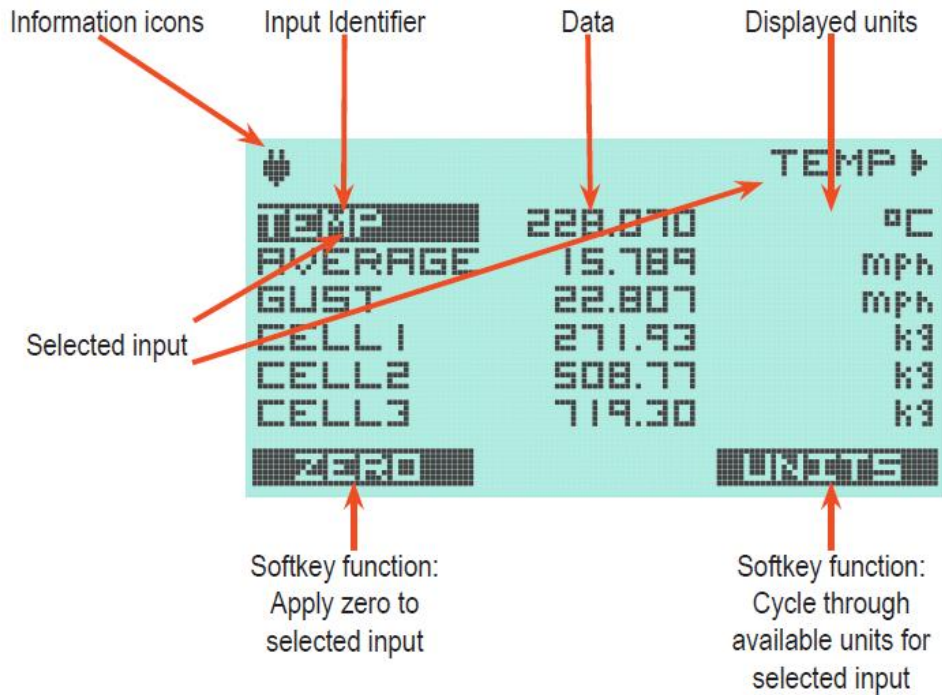

The List display shows live data from up to six inputs at once (12 are available with scrolling). In defined mode the first column will show the assigned name of the input. The second column shows the data and the third is the selected units. The selected input is highlighted and shown in the top right corner. Softkey 1 applies a zero to the selected input or returns to the gross value. Softkey 2 has no function. Softkey 3 cycles through the available measurement units for the selected input. The up and down keys scroll through the available inputs. The left key displays the Radio display. The right key displays the Detail display.

Detail

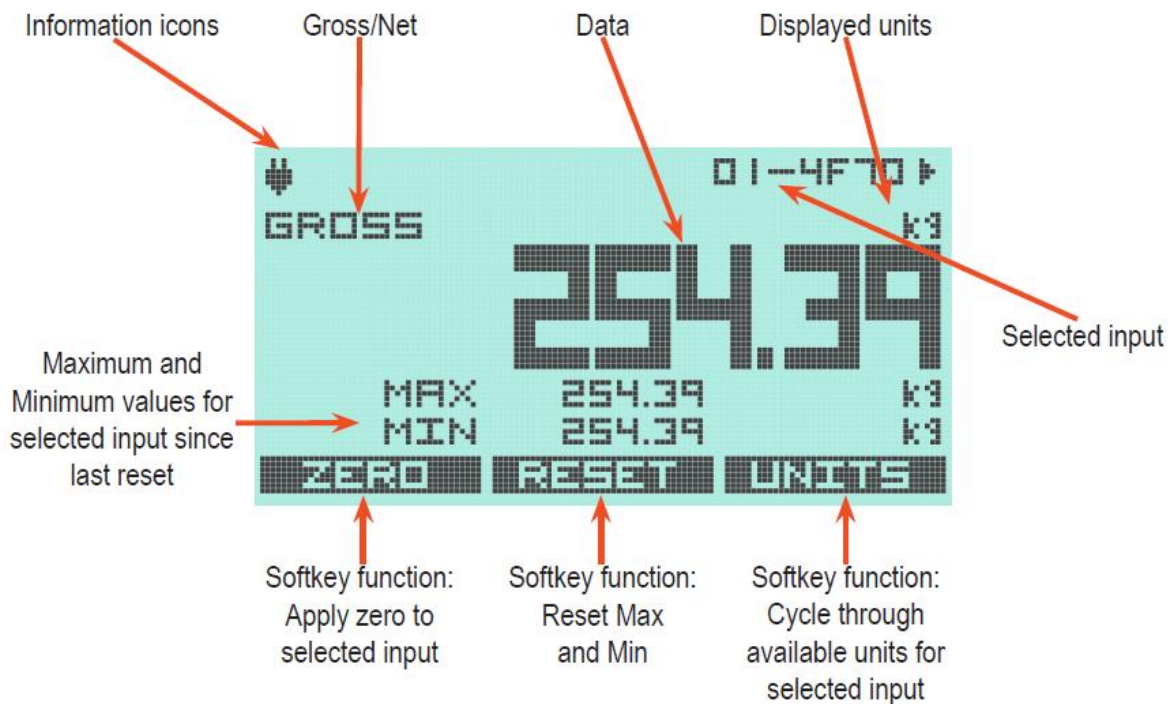

The Detail display shows the data from one input. It also shows the maximum and minimum values detected for this input since the last reset. The selected input is shown in the top right corner. Softkey 1 applies a zero to the selected input or returns to the gross value. Softkey 2 resets the maximum and minimum for this input. Softkey 3 cycles through the available measurement units for the selected input. The up and down keys scroll through the available inputs.

The left key displays the List display. The right key displays the Radio display.

Radio

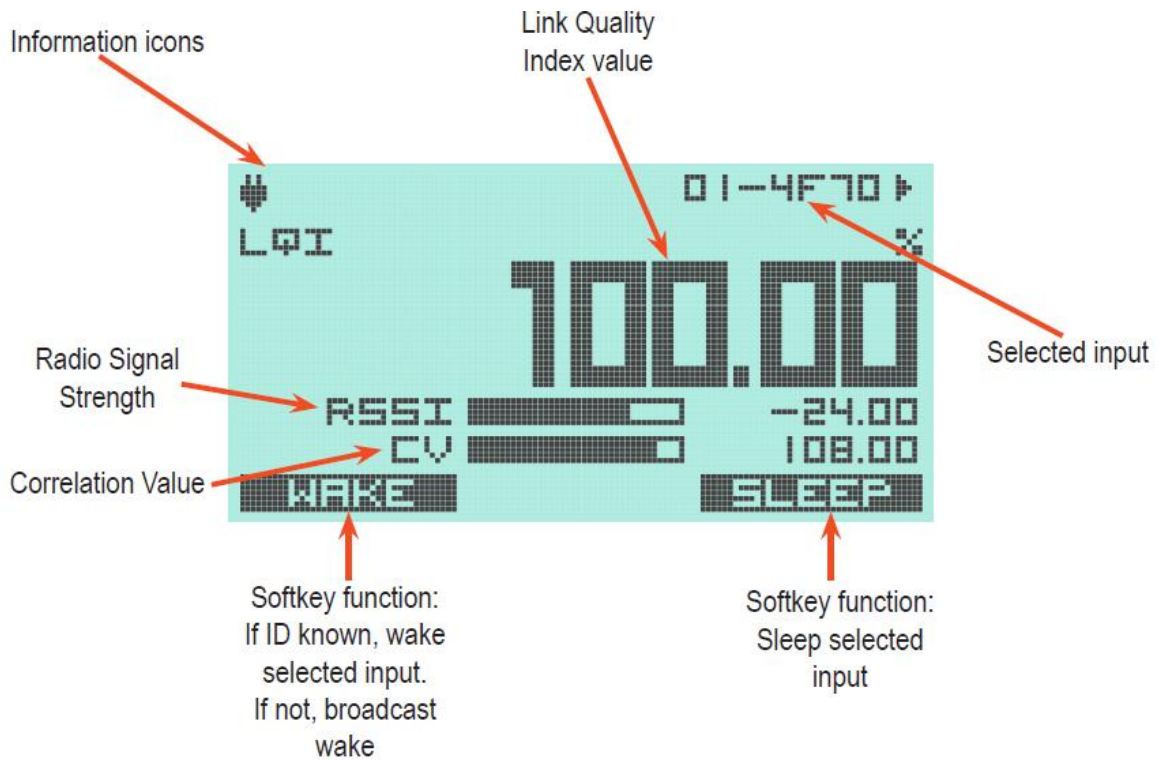

The Radio display shows the radio quality from one input. The selected input is shown in the top right corner. Softkey 1 will wake the transmitter of the selected input if the ID is known (eg in defined mode) or will send a broadcast wake if not known. Softkey 2 has no function. Softkey 3 sends the transmitter of the selected input to sleep. The up and down keys scroll through the available inputs. The left key displays the Detail display. The right key displays the List display.

Icons

In the top left of all displays are information icons.

	One of the input channels has triggered a warning action		External USB power has been applied.
	One of the input channels has triggered an overload action		The selected display is showing the Net value because a Tare has been executed.
	One of the input channels has triggered an underload action		The keypad has been locked because some critical processes are being performed by the Toolkit or other software
	There is an error with one of the BW transmitters		Battery is low
	The temperature is now too low to operate the LCD at its normal update rate. A slower update rate has been applied. Note that internal measurement (such as peak detection) will not be affected.		

Configuration Using the Menu System

It is possible to carry out the majority of the setup of the BW-HK-S simply by using the handheld. This is carried out using the menu system. It is possible for the user to hide or lock parts of the menu system for simplicity and to stop users changing settings accidentally. This is done using the toolkit and is explained below.

To open the menu system simply power up the handheld and click Menu/OK. Navigation is then achieved using the Up/Down keys, OK key and the softkeys. The Left key has the same functionality as the Back softkey and the Right key has the same functionality as the OK key.

The menu is quite extensive and is divided up into the following top level menus.



System

The System menu covers setting relating to the basic functionality of the system such as display brightness and key actions. See below for the System menu structure and explanations of the items. To access the System menu it may be necessary to enter a PIN. By default this is 1000 but this could have been changed in the toolkit.

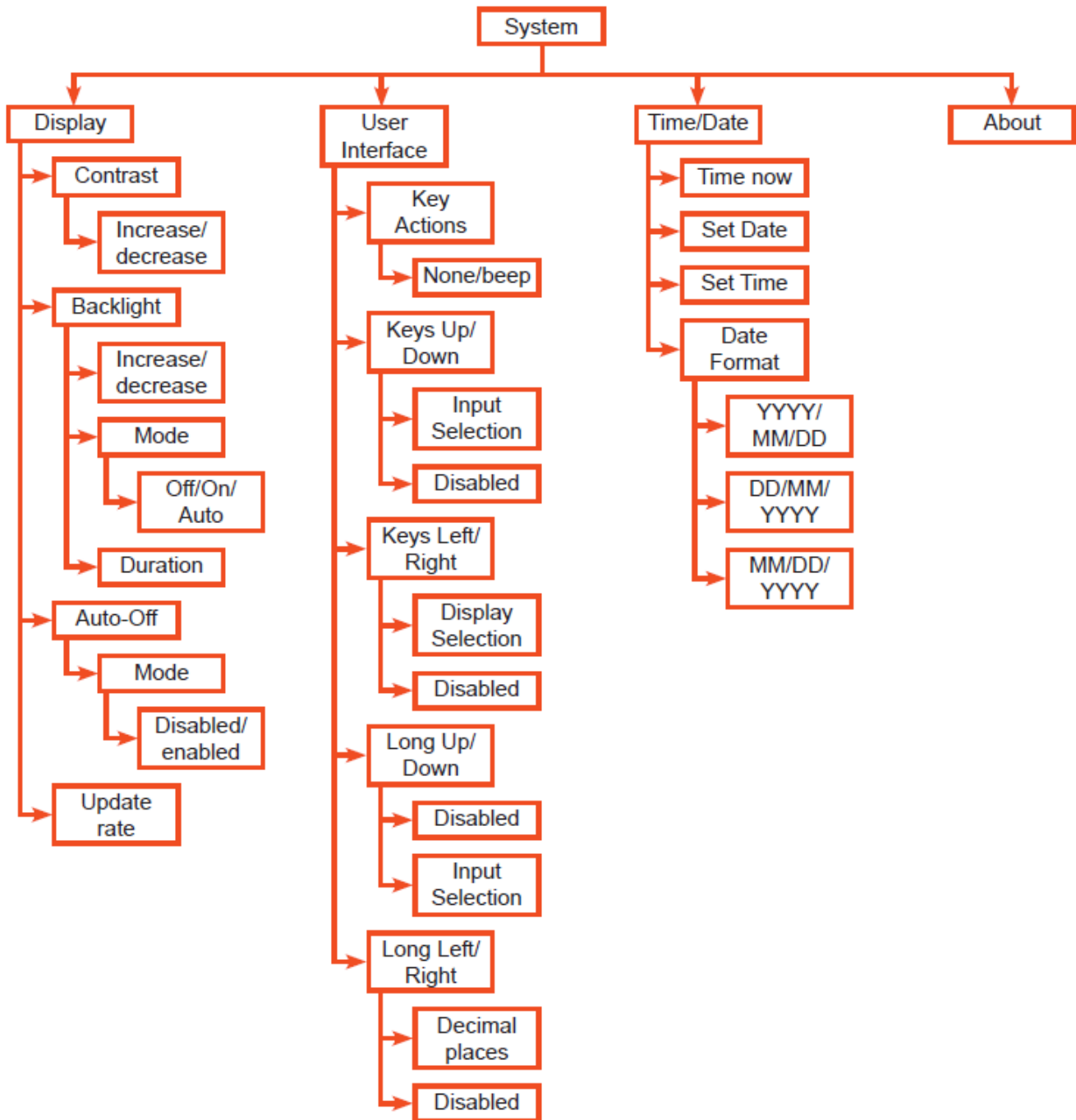

Display

Contrast

Here you can change the contrast of the display to allow viewing from other angles.

Contrast | Increase/decrease

Backlight

Here you can change the brightness of the backlight and select power saving options.

Off	Backlight is always off
On	Backlight is always on
Auto	Backlight switches off after the keypad has not been pressed for the duration set below. Backlight comes back on if any keys are pressed. (disabled if connected to USB power)

Duration	Time in seconds that the backlight will switch off if auto is selected
-----------------	--

Auto-Off

Power saving mode that controls whether the handheld switches off completely after a period with no key presses. If enabled, set the time in minutes that must elapse without a key press for the handheld to power down.

Mode	Enabled/disabled
Timeout	Time in minutes for the handheld to switch off

Update rate

Rate at which the display is updated (regardless of how quickly data is coming in). Slower rates will increase battery life. Rates available from 200-1000 milliseconds.

User Interface

Key Actions

Choose whether the handheld beeps or not when a key is pressed

Key Functions

These are hidden by default and are probably best accessed using the toolkit below.

This allows disabling the keypad functionality when not in the menu system.

A long press is approximately 1 second.

Keys Up/Down	Select Input or Disabled
Keys Left/Right	Select Display or Disabled
Long Up/Down	Disabled or Select input
Long Left/Right	Increase/Decrease decimal places of selected measurement unit or Disabled

Time/Date

Set and view the internal clock

Time now	View current time in handheld
Set Date	Set the date
Set Time	Set the time
Date Format	Choose between the different date formats

About

Displays information about the handheld, eg product name, serial number and firmware version.

Actions

The Actions menu allows setting of the source of the trigger for the actions. Also it allows selecting what actions happen on different events.

To access the Actions menu it may be necessary to enter a PIN. By default this is 2000 but this could have been changed in the toolkit.

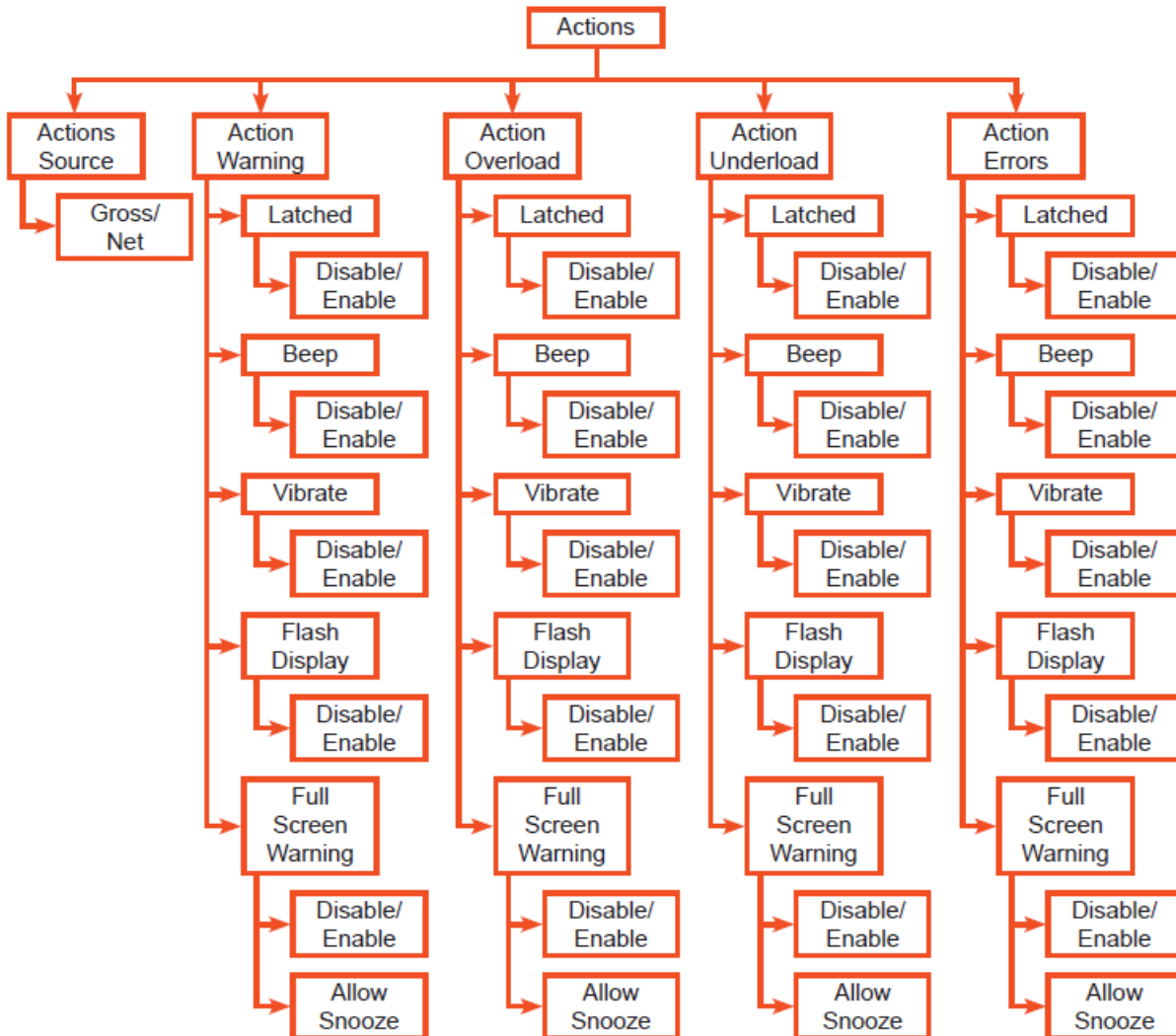

Actions Source

Here it is possible to choose between Gross and Net as the source for triggering warnings etc.

Actions Source | Gross or Net

Action (warning, overload, underload and error)

Each of the different error types can give different actions or they can all do the same thing. Even if no actions are selected here, the Information Icons in the top left of the display will show any errors that have occurred.

Latched	If enabled, error and actions will stay active until unlatched in the Info menu below
Beep	Enable/disable beep on error state
Vibrate	Enable/disable vibrate on error state
Flash Display	Enable/disable flash display on error state. The relevant display will flash, showing which input has triggered the error
Full Screen Warning	Enable/disable full screen warning stating which type of error has been triggered. This will continue to cover the measurement pages until the error has cleared.
Allow snooze	Enable/disable ability to temporarily hide the Full Screen Warning to be able to see the main displays.

Inputs Setup

The Inputs Setup menu allows setup of the data that the handheld is going to display.

To access the Inputs Setup menu it may be necessary to enter a PIN. By default this is 3000 but this could have been changed in the toolkit.

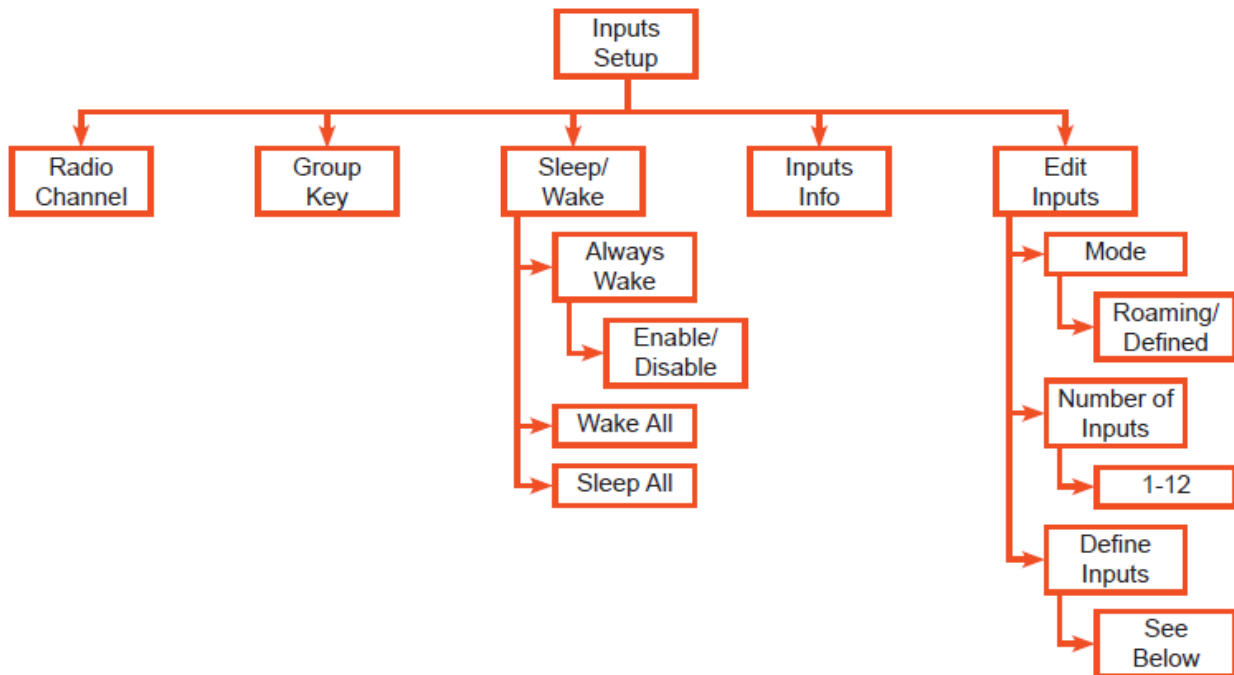

Radio Channel and Group Key

Set the radio settings of the handheld. To view data from any transmitters the radio settings must match.

Radio Channel	Set the radio channel that the handheld will be operating on. 1-15 available.
Group Key	Set the group key that the handheld will be using.

Sleep/Wake

Always Wake	When enabled, the handheld will try to wake all available transmitters in the vicinity with the same radio settings. If the inputs have been defined then they will be the transmitters being woken.
Wake All	Temporarily send a wake command to all available transmitters in the vicinity with the same radio settings. If the inputs have been defined then they will be the transmitters being woken.
Sleep All	Temporarily send a sleep command to all available transmitters in the vicinity with the same radio settings. Only the transmitters in the list (roaming or defined) will be slept.

Inputs Info

Shows a summary of the current input list (either roaming or defined) with name, ID (if set) and incoming measurement units.

Edit Inputs

Mode	
Roaming	When in roaming mode, the handheld will fill the list with the first (number of inputs) that it receives. There are global settings applied to these (EG warning and timeout)
Defined	In defined mode, the handheld is looking for specific inputs and each input channel can have a different configuration. (EG overload and units)
Number of Inputs	Select the maximum number of inputs that will be shown by the handheld.
Define Inputs	This menu is different depending on whether the handheld is in roaming or defined mode. See below for further details

Define Inputs (roaming)

You may have to enter a password to get into this menu. By default this is DEF but it can be changed in the toolkit.

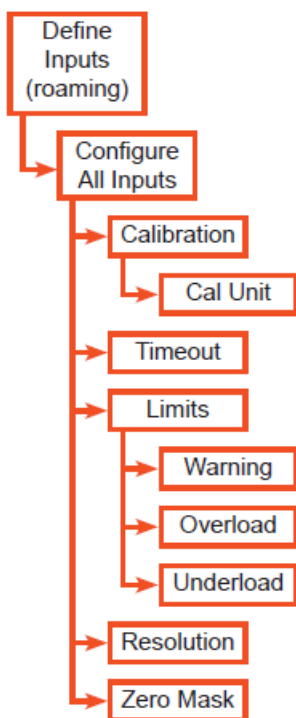

Note that these settings are applied to all inputs when in roaming mode

Calibration	Here you can set the base measurement unit of the incoming data
Timeout	If the handheld has not received data from the transmitter assigned to a input for more than this time then horizontal dashes will appear instead of a number
Limits	Set the thresholds for triggering the three different limits. Warning, overload and underload. Actions that will occur when these are triggered are set above
Resolution	The resolution of the base units set above. The display will change in increments of this value
Zero Mask	If the incoming value is less than this value then the display will show zero

Define Inputs (defined)

You may have to enter a password to get into this menu. By default this is DEF but it can be changed in the toolkit.

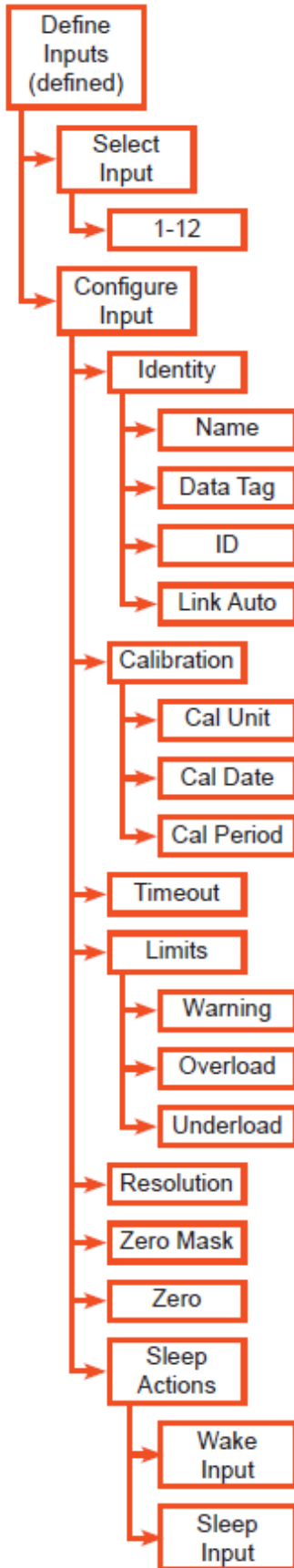

These settings need to be set for each active input channel

Select Input	Select the input to be configured below
--------------	---

Configure Input	
Identity	
Name	Name assigned to this input
Data Tag	Data tag of the BW transmitter for this channel
ID	ID for the incoming data for this channel, only required for targeted wake.
Link Auto	Follow the on screen instructions to power cycle a transmitter to grab its ID and data tag. The transmitter will also be pulled to the same radio settings as the handheld (set above)
Calibration	
Cal Unit	Here you can set the base measurement unit of the incoming data
Cal Date	Date that the transmitter was calibrated
Cal Period	Length of time in days that the calibration is valid for
Timeout	If the handheld has not received data from the transmitter assigned to this input for more than this time then horizontal dashes will appear instead of a number
Limits	
Warning	Set the threshold for triggering the warning limit. Any value above this will trigger the actions for warning set above
Overload	Set the threshold for triggering the overload limit. Any value above this will trigger the actions for overload set above
Underload	Set the threshold for triggering the underload limit. Any value below this will trigger the actions for underload set above
Resolution	The resolution of the base units set above. The display will change in increments of this value
Zero Mask	If the incoming value is less than this value then the display will show zero
Zero	
Sleep Actions	
Wake Input	Wake the currently selected input (if ID is known)
Sleep Input	Sleep the currently selected input

Info

Here you can access Information about the handheld and transmitters connected to it without being able to edit anything. There is no PIN to access this menu.

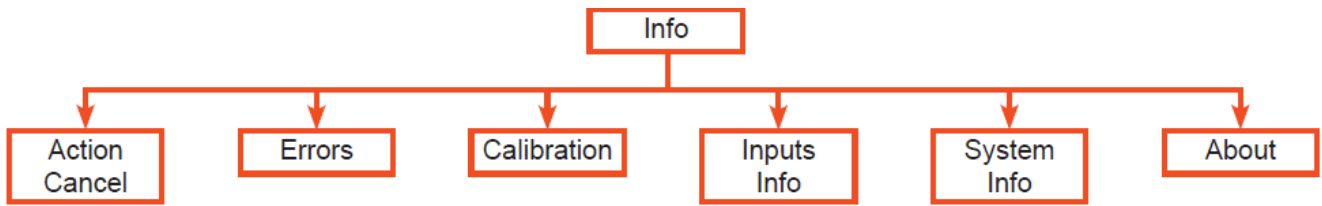

Action Cancel

Only visible if an action has been triggered and is latched

Errors

Any current errors detected for each channel will be displayed in a simple table here. This will include any latched errors.

U	Underload
W	Warning
O	Overload
I	Integrity Error (transmitter)
C	Shunt Cal Active (transmitter)
B	Battery Low (transmitter)
S	Signal Low (transmitter)
E	Remote Error (transmitter)

Calibration

Shows the calibration state of the defined transmitters. This is hidden by default.

Inputs Info

Shows a summary of the current input list (either roaming or defined) with name, ID (if set) and incoming measurement units.

System Info

Shows some system info for diagnosis. The table is static and only populated each time the menu is opened.

Battery	Voltage of battery
USB Link	Whether USB is successfully connected
Temperature	Internal temperature of handheld
System Flags	For fault finding
Startup code	For fault finding

About

Displays information about the handheld, eg product name, serial number and firmware version.

Configuration Using the Toolkit

The **NEW Broadweigh Handheld Toolkit** is required for full configuration of the BW-HK-S. This is in a familiar format to the current one and provides a means of simple configuration of the handheld module. It will not allow configuration of the legacy handhelds.

Launch the Broadweigh Handheld Toolkit software application and connect the BW-HK-S to the PC using a USB cable.

Home

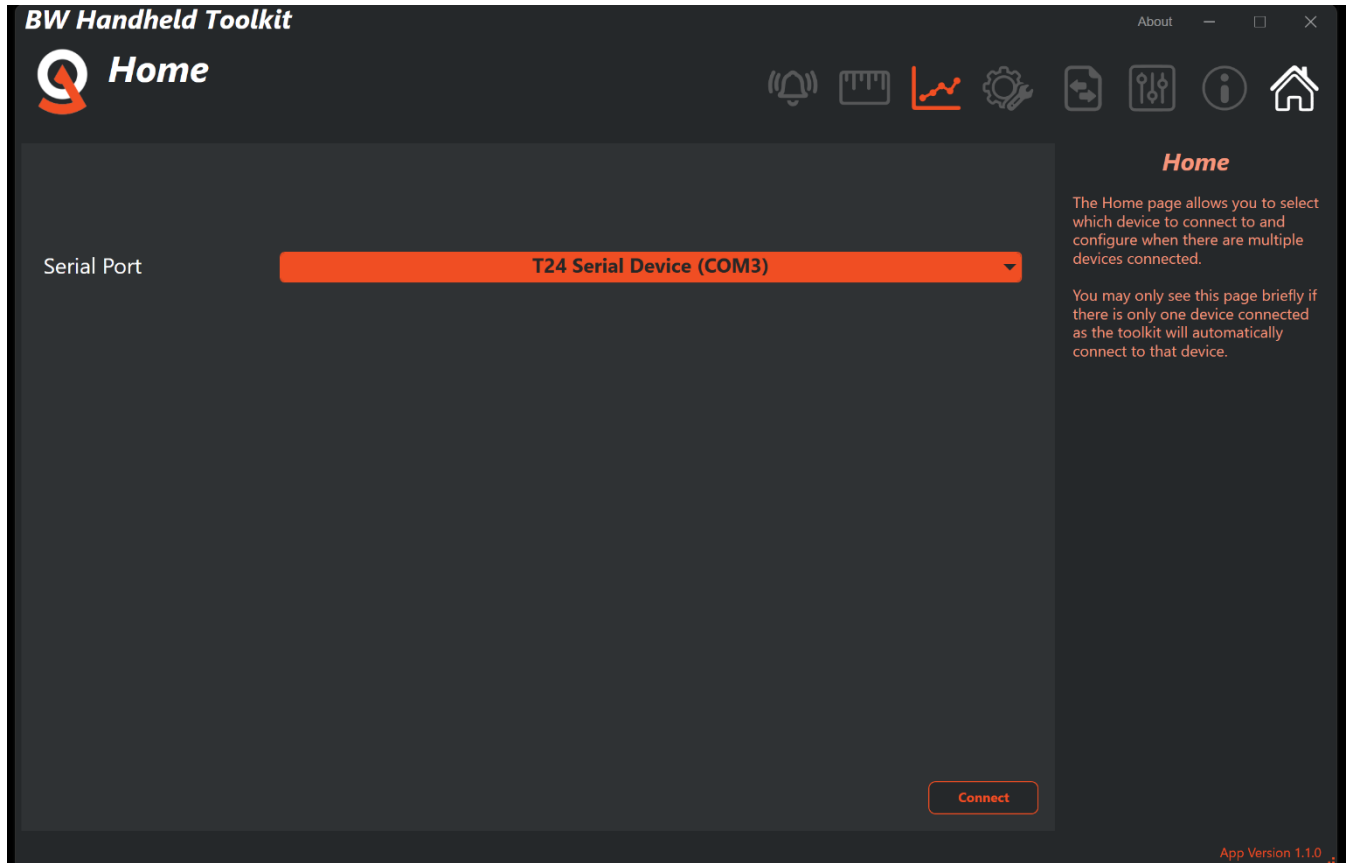

The Home page allows you to select the correct device and connect to it. Additionally, if there is no device connected, you can go to the logging page and load a previous log file for review. On the right there is a sidebar help for the current page. You can hide this using the F12 key.

Items you can change:	
Serial Port drop-down	Select from the connected BW-HK-S devices
Connect button	Connect to the selected device

Information

BW Handheld Toolkit Information

Information

Device Information	Status
Model: BW-HK-S	Battery Voltage: 2.675
Serial Number: 17874319	Battery Status: GOOD
Hardware Version: 2.05	
Firmware Version: 1.04	
Bootloader Version: 1.00.000	
Software Version: 1.04.000	
App Version: 1.04.000	
API Version: 1.11.000	Time: 11:02
Platform Version: 1.19.000	Date: 09/19/2025

Connected to BW-HK-S s/n 17874319 on COM6

App Version 1.4.0

The Information page shows information about the connected handheld. This can be useful for fault finding.

The icons along the top may be different depending on whether pages in the toolkit have been locked behind the Configuration password.



If pages have been locked, click on the padlock to enter the password and gain access to the complete toolkit.

Settings

The Settings pages allow editing of various user interface settings.

Interface

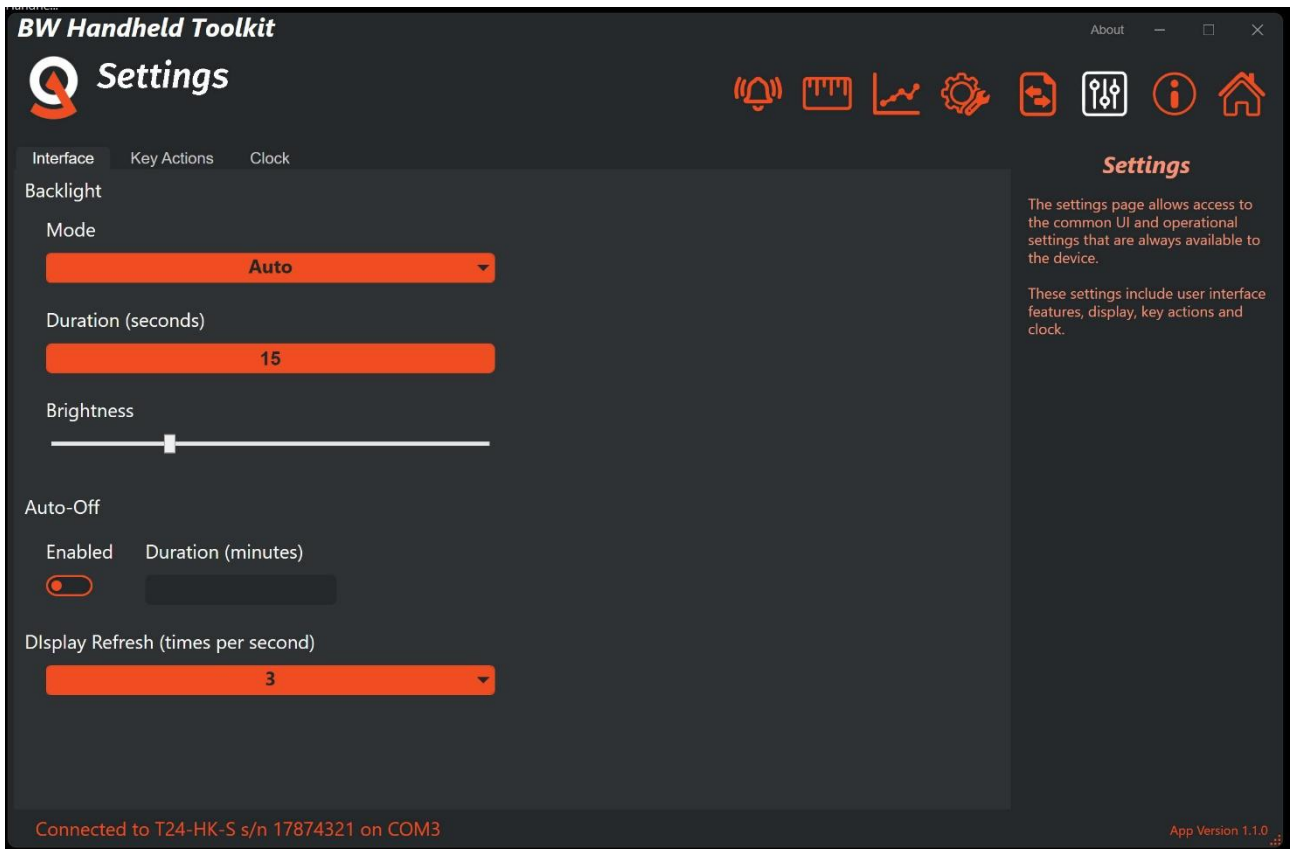

The Interface tab permits changing settings relevant to power consumption.

Items you can change:	
Backlight	
Mode drop-down	Select the required operational mode for the backlight. Choices are: Off The backlight remains off On The backlight is on all the while the handheld is turned on Auto The backlight will come in when a key is pressed and turn off again if no key is pressed for the duration set below
Duration (seconds) entry field	Set the time to wait without a key press before the backlight turns off. Only applies if mode is set to auto
Brightness slider	Change backlight brightness. Move the slider to set the desired backlight brightness level. A brighter backlight will result in reduced battery life.
Auto-Off	
Enabled switch	Set to ON to automatically turn off the handheld if keys are not pressed for a specified duration
Duration (minutes) entry field	Set the time to wait without a key press before the backlight turns off
Display Refresh drop-down	Select the required update rate of the display. Faster updates will result in reduced battery life. (1-5 updates per second available)

Key Actions

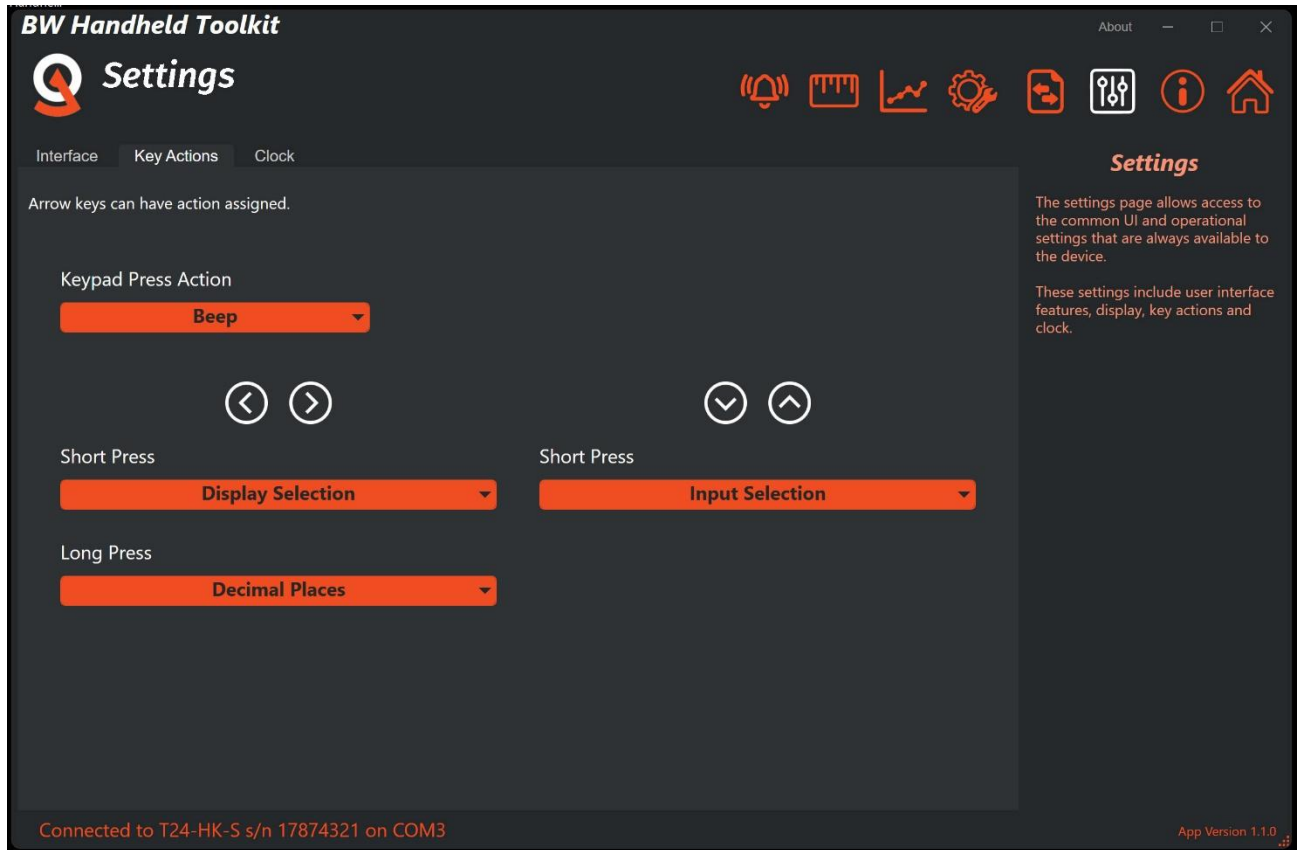

The Key Actions tab allows enabling and disabling of key functions

Items you can change:					
Keypad Press Action drop-down	Select the required action when a key is pressed:				
	<table border="0"> <tr> <td>None</td> <td>Makes no sound</td> </tr> <tr> <td>Beep</td> <td>Briefly sound the buzzer</td> </tr> </table>	None	Makes no sound	Beep	Briefly sound the buzzer
None	Makes no sound				
Beep	Briefly sound the buzzer				
Left/Right					
Short Press drop down	Select the action to take place when the Left/Right keys are pressed				
	<table border="0"> <tr> <td>Display Selection</td> <td>Cycle through the available displays</td> </tr> <tr> <td>Disabled</td> <td>No action</td> </tr> </table>	Display Selection	Cycle through the available displays	Disabled	No action
	Display Selection	Cycle through the available displays			
Disabled	No action				
<table border="0"> <tr> <td>Decimal Places</td> <td>Increase or decrease the number of decimal places displayed for the currently selected unit type</td> </tr> <tr> <td>Disabled</td> <td>No action</td> </tr> </table>	Decimal Places	Increase or decrease the number of decimal places displayed for the currently selected unit type	Disabled	No action	
Decimal Places	Increase or decrease the number of decimal places displayed for the currently selected unit type				
Disabled	No action				
Up/Down					
Short Press drop down	Set the time to wait without a key press before the backlight turns off				
	<table border="0"> <tr> <td>Input Selection</td> <td>Cycle through the available inputs</td> </tr> <tr> <td>Disabled</td> <td>No action</td> </tr> </table>	Input Selection	Cycle through the available inputs	Disabled	No action
	Input Selection	Cycle through the available inputs			
Disabled	No action				

Clock

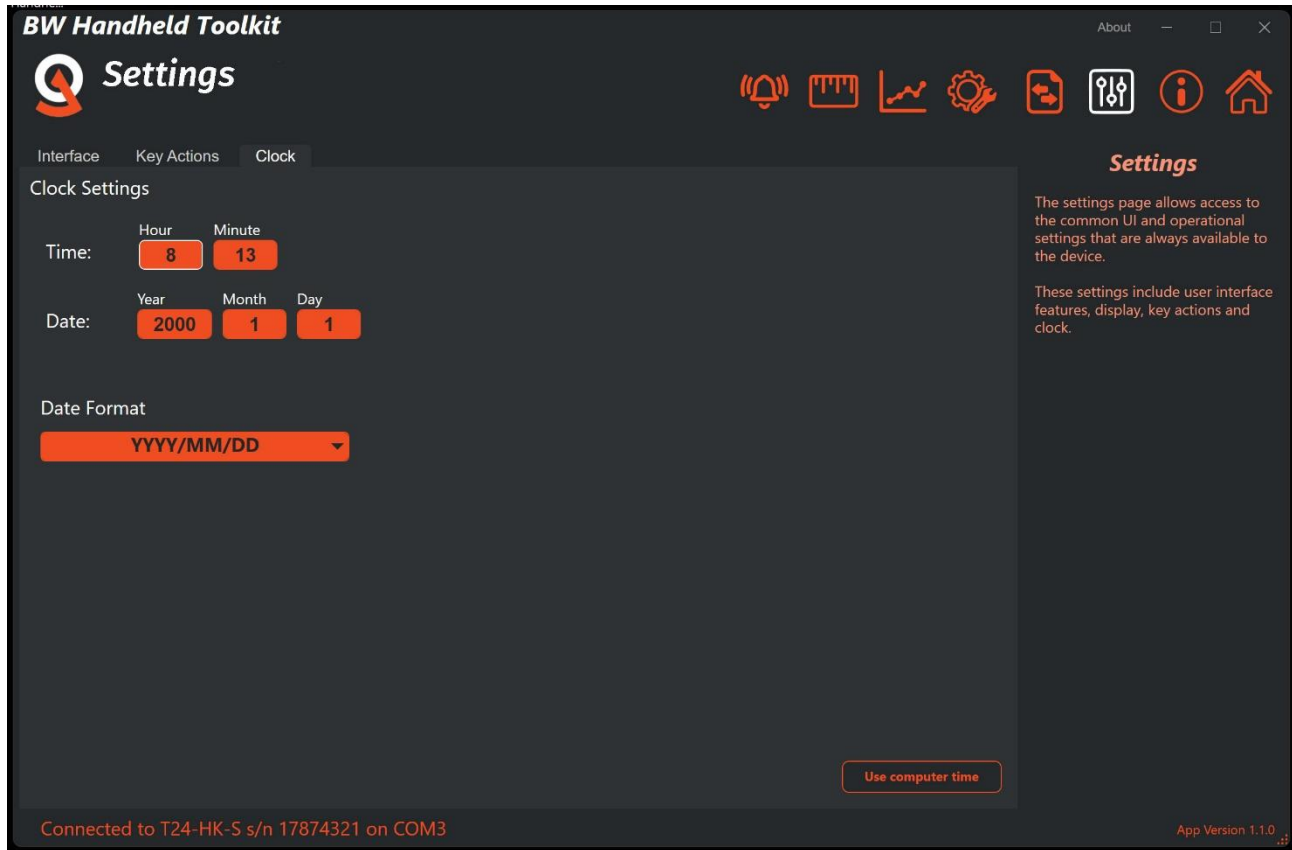

Here you can configure the device real-time clock



Note: If the batteries are removed for more than half an hour (and the handheld is not being powered by USB) the real time clock may need resetting after the new batteries have been fitted.

Items you can change:	
Hour, Minute entry fields	Set the handheld internal time
Year, month, day entry fields	Set the handheld internal date
Date format drop down	Select the desired date format
Use computer time button	Set handheld to current PC time and date

Import & Export

This page allows you to export the settings from the connected device for later import into the same, or another, device. Depending on whether certain sections are locked you may not be allowed to export.

There are two ways to export data:

Standard Export – allows all settings that are not locked to be exported and then on import the user can choose which sections to overwrite. It is good practice to retain a copy of the exported settings file in case settings need to be restored in the future. Also note that technical support may ask for this file to aid trouble shooting.

Clone Export – The entire device is exported and on import will create a clone of the original device. Any locked/protected sections are still respected so no exports can be made from a locked device nor can a locked device be overwritten without knowledge of the passwords.

Export

BW Handheld Toolkit About — □ ×

Import & Export

This page allow you to export the handheld settings to a file which can later be imported into another handheld or used to restore settings to the same handheld.

Export Import

Click the Export button to export the data without specially configured (and protected) section.

Click the Clone Export button to provide the password to unlock protected sections or to prepare an advanced Clone export to enable cloning and updating of protected data.

**This handheld has had its Inputs protected!
A normal export will not include it.**

Clone Export **Normal Export**

Connected to BW-HK-S s/n 17874319 on COM6 App Version 1.4.0

Import & Export

The configuration of the device can be exported to a file and later imported.

The import export respects the optionally protected parts of a device so you may not be able to import calibration or configuration sections if your device has been locked.

This page allows you to perform a simple Export or an advanced Clone Export.

Export – This exports device settings to a file on the PC which will contain all data except for configuration data if that section has been locked.

Clone Export – See the next section in the manual.

Also see Import later in the manual for information about using these exported data files.

Item	Description
Export button	Export configuration to a file on the PC. This will open a file dialog box to allow you to specify where the export will be saved.
Clone Export button	See the next section in the manual.

Clone Export

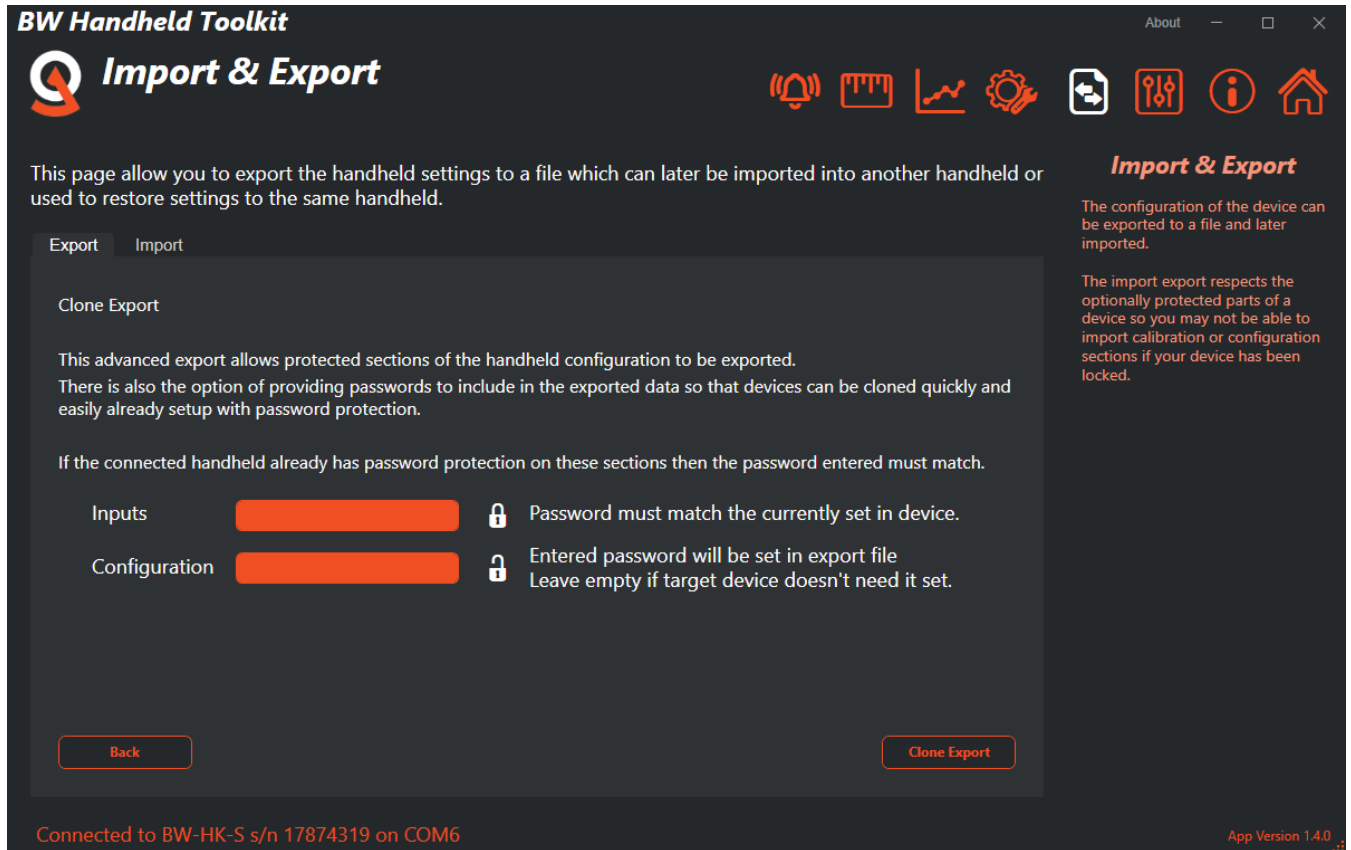

Clone Export is an advanced form of export that offers the ability to export data that may be locked and protected by a password and also allows passwords to be encrypted into the exported file and get applied to the freshly cloned device when imported.

When creating the Clone Export file an optional password may be supplied to automatically apply protection to the cloned device when imported.

i It is important that these passwords are not forgotten. Resetting of a forgotten password will require proof of access rights and may require a return to supplier and may incur additional cost.

If the connected device has a password locked calibration or configuration section then the same passwords **must** be entered to proceed.

Summary: To successfully create a Clone Export the connected device must be unlocked or the passwords known for those locked sections. If a section is currently unlocked, then a password may be supplied at this point to be automatically applied to the cloned device later.

Item	Description
Inputs entry field	If Inputs password is already set in handheld you must enter it here for export to work If password is not set, you can set one here to be included in the export file
Configuration entry field	If Configuration password is already set in handheld you must enter it here for export to work If password is not set, you can set one here to be included in the export file
Back button	Go back to standard export page.
Clone Export button	<i>Export Clone configuration to a file on the PC.</i> This will open a file dialog box to allow you to specify where the export will be saved.

Import

BW Handheld Toolkit About — □ ×

Import & Export

This page allow you to export the handheld settings to a file which can later be imported into another handheld or used to restore settings to the same handheld.

Export **Import**

Select File

Import

Connected to BW-HK-S s/n 17874319 on COM6 App Version 1.4.0

Import & Export

The configuration of the device can be exported to a file and later imported.

The import export respects the optionally protected parts of a device so you may not be able to import calibration or configuration sections if your device has been locked.

This page allows you import a previously exported file.

The file you choose may be one of two types and this may present further options depending on its type:

Item	Description
Select file button	Opens a file selection window to allow finding of the correct file for importing
Import button	Once the file is selected, click this to carry out import

Standard Export File

If a standard export is selected then this page will be displayed:

Import & Export

This page allow you to export the handheld settings to a file which can later be imported into another handheld or used to restore settings to the same handheld.

Export Import

Select File C:\Users\tom\Desktop\standard1.bck

Import created: 19/09/2025 11:14 Import type: Normal

Select which sections of the handheld to overwrite with the imported data file.

Inputs

Configuration

Other Settings

Import

Connected to BW-HK-S s/n 17874319 on COM6 App Version 1.4.0

You can choose which sections to import. The choices available will depend on whether they are present in the data file and whether those sections are protected in the connected device itself.

Item	Description
Select file button	The file has already been selected and is being displayed
Inputs switch	Select this switch to import Input settings
Configuration switch	Select this switch to import Configuration settings
Other Settings switch	Select this switch to import Other settings
Import button	Once the file and the required settings are selected, click this to carry out import

Clone Export File

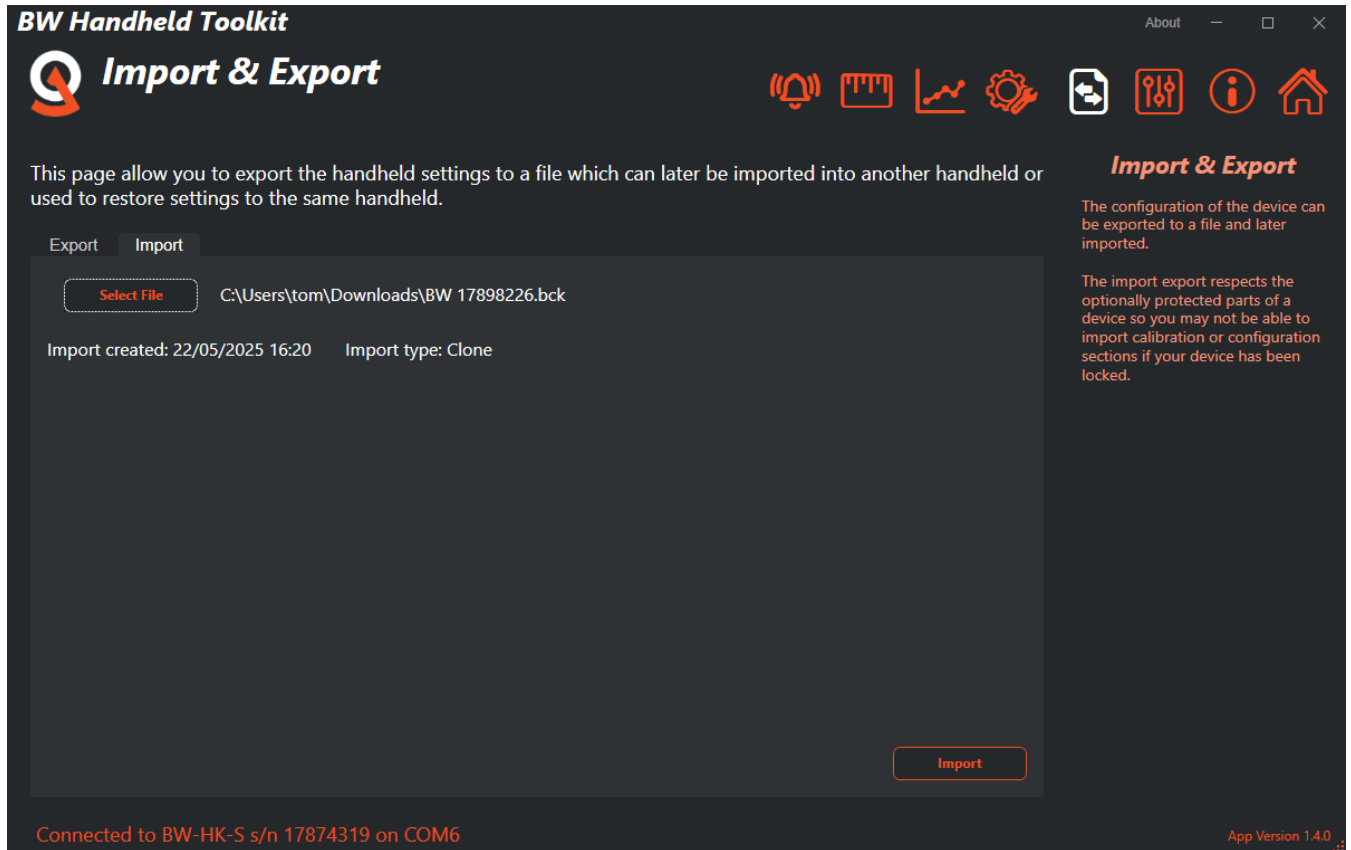

To successfully import a Clone Export file, either the calibration and configuration sections must be unprotected in the connected device or the passwords encrypted in the data file must match those in the protected sections of the connected device.

After selecting the file the toolkit will inform you whether the data can be imported and if it can you can choose to click the Import button to perform the cloning action.

When cloning a handheld, all configuration, user calibration and user settings are duplicated leaving only the original factory settings and factory calibration intact

i NOTE: If the Clone Export file contains encrypted passwords to protect either the calibration or configuration sections then it must be understood that those sections will become locked in the connected device once the data file is imported. There is no way to unlock a protected section if the password is unknown (Resetting of a forgotten password will require proof of right to access and may require a return to supplier and incur additional cost.) so be sure that the source of the Clone data file is trusted or that you know the passwords yourself. (It is normal for a provider of a locked down device to provide a Clone data file that can update that device.)

Item	Description
Select File button	Click to open a file select dialog box to allow you to choose the location of the file to import.
Import button	Perform the import.

Configuration

The Configuration page enables tailoring of the functionality of the handheld. Menus and displays can be hidden to make the end user's experience simpler. Passwords can be set to ensure that settings are not changed by accident.

i This page may have been locked with the configuration password. If so, click the padlock to enter the password and unlock.

Menus

BW Handheld Toolkit Configuration

When you security lock features you need to provide a password.

Menus | Display Modes | Units | Custom Units | Pins | Firmware Upgrade | Management

Select which items will be visible/available to the user.

* These menu items are only visible when in Defined Inputs mode.

- System Menu
- Actions Menu
- Inputs Menu
 - Radio Channel
 - Group Key
 - Sleep/Wake
 - Inputs Info (Tag/ID/Unit)
 - Edit Inputs
 - Mode
 - Number of Inputs
 - Define Inputs
 - Info

Save

Configuration

The configuration page allows access to many features of the device including which calibration and display modes are selectable, which units are available and which menu items are available.

This is also the only place where the display modes can be defined.

This entire section can be locked down to preserve the configured integrity of a device so you may find you cannot gain access to this section

Connected to BW-HK-S s/n 17874319 on COM6

App Version 1.4.0

This page allows you to hide unwanted menus for a simpler user experience.

Item	Description
Various tick box	Select/deselect the various menus as required
Save button	Click to save once changes to menus are complete

Display Modes

BW Handheld Toolkit Configuration

When you security lock features you need to provide a password.

Menus | Display Modes | Units | Custom Units | Pins | Firmware Upgrade | Management

The following display modes can be hidden from the user.

- List
- Detail
- Radio

Configuration

The configuration page allows access to many features of the device including which calibration and display modes are selectable, which units are available and which menu items are available.

This is also the only place where the display modes can be defined.

This entire section can be locked down to preserve the configured integrity of a device so you may find you cannot gain access to this section

Connected to BW-HK-S s/n 17874319 on COM6 App Version 1.4.0

Here you can hide any of the available displays if not required (eg there is no need for a list display if there is only one transmitter in the list).

Item	Description
List Switch	Show/hide the 6 line list display
Detail Switch	Show/hide the single detail display
Radio Switch	Show/hide the radio signal strength display

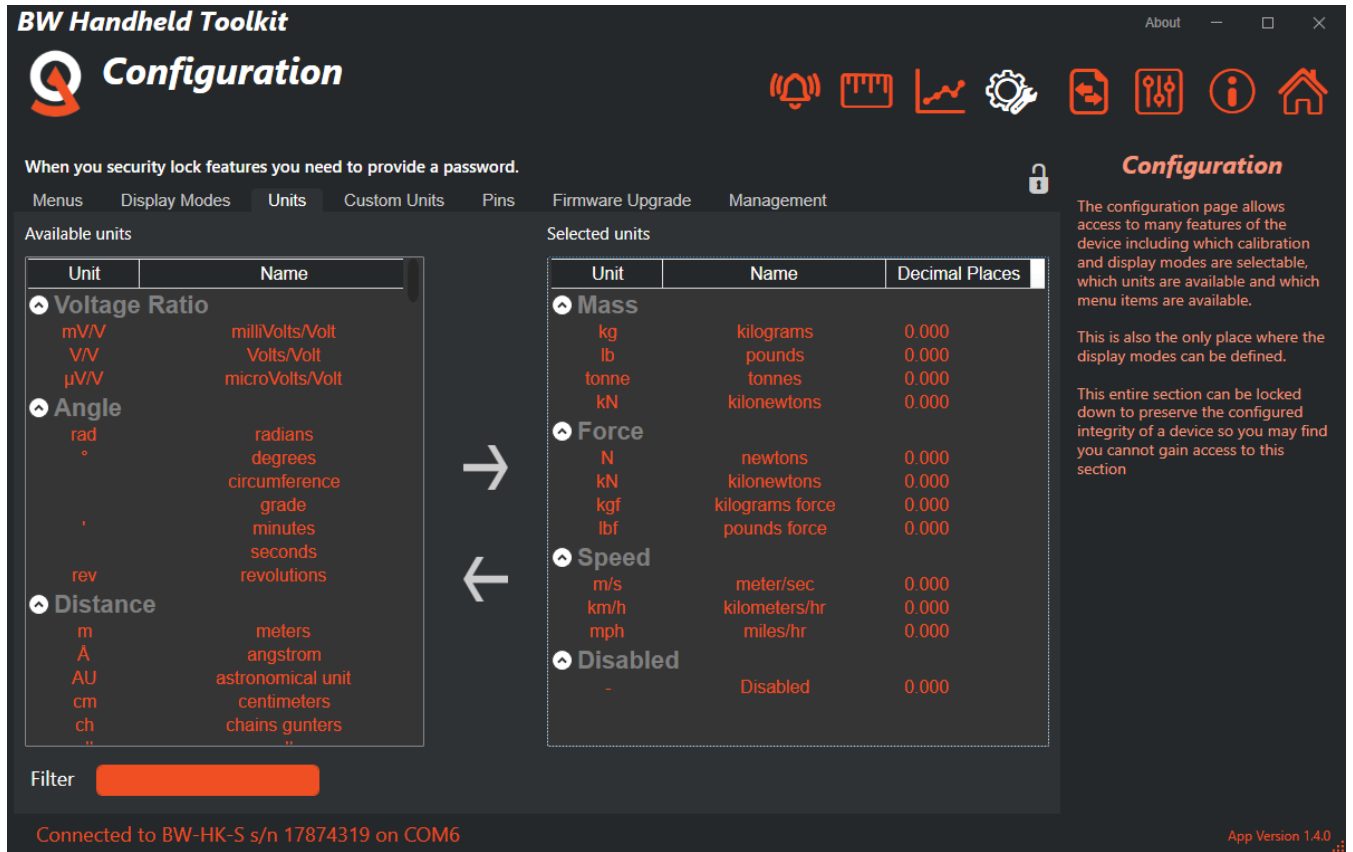

This section allows you to define which units of measure are available for calibration as the base engineering units and also any unit conversions that are selectable from the Units soft key that appears on most display modes.

Two lists are displayed. The left one shows all available units that are *not* currently enabled and the one on the right shows the units that are available for calibrating or conversion.

To change items between the two lists simply select one or more items (Hold CTRL keyboard key to select multiple items) and click the appropriate arrow symbol.

i When the user uses the Units soft key to cycle around selected units the list will be limited to those that are relevant to the calibrated base units.

i Each unit has a definable display format that sets the desired number of decimal places shown. The format can be changed here by right clicking the field in the Decimal Places column and selecting the desired format from the pop-up list.

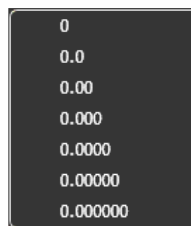

i Note that the decimal places can also be modified (globally for the currently displayed engineering units) by using a long press on the keypad left and right direction keys (If this action has been allowed).

To aid finding different units there is a filter field that can be typed into.

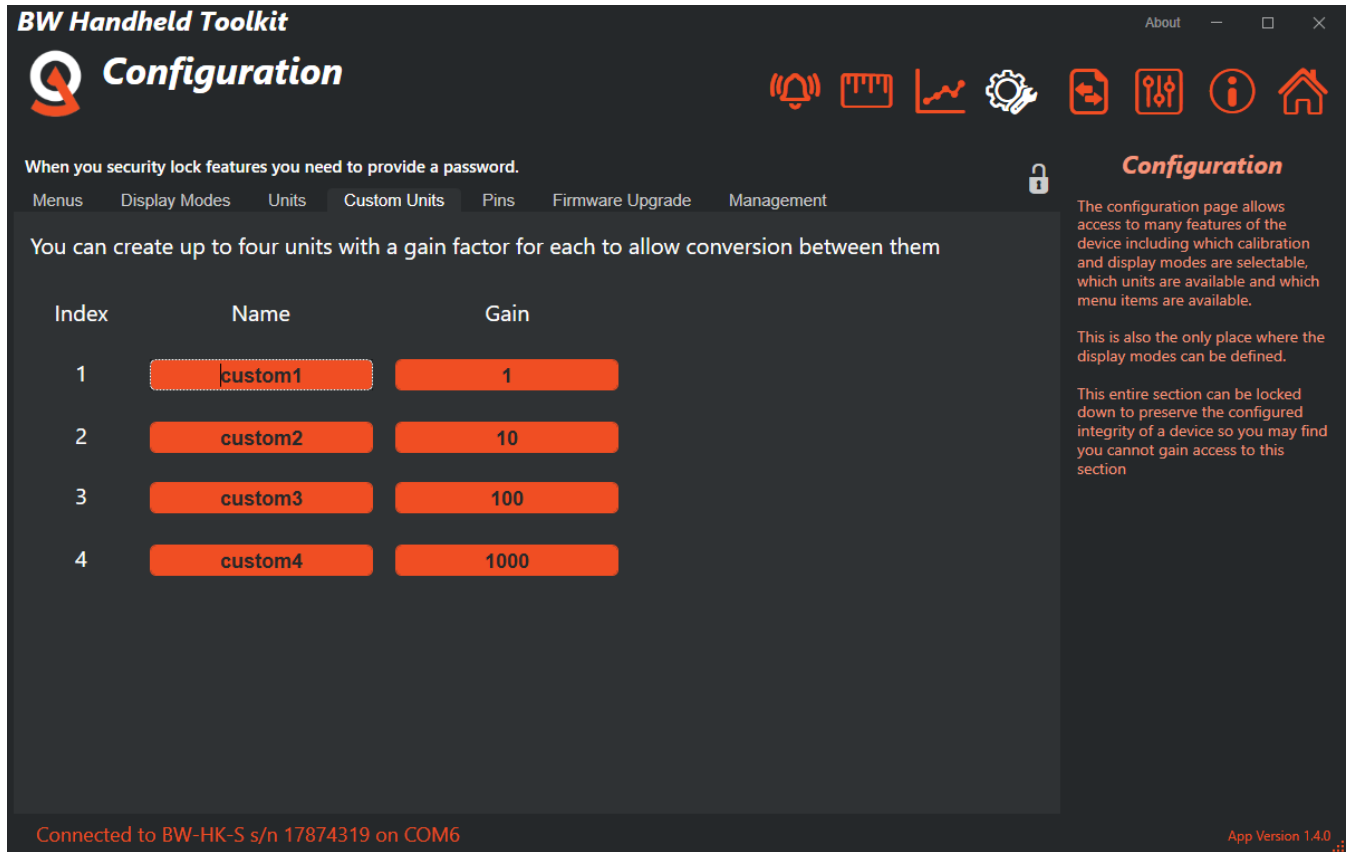

If the comprehensive list of built in units and automatic conversion does not contain the engineering units you need then this tab allows you to create your own.

You can create up to four units with a gain factor for each to allow conversion between them.

See the Units section for a list of supported unit categories and units. You will notice the four custom units at the end of the table. These are selectable as either calibrated or available display units and the conversion factors used and the description shown will come from the data entered here.

Item	Description
Index label	Indicates the index of the custom unit.
Name entry field	Enter the text to be displayed for this custom unit. i.e. kg, lbs etc.
Gain entry field	Enter a gain value for this custom unit. The gain value indicates how to convert between the different custom units. For example, if you were trying to enter mass units and wanted kg and lbs you could enter kg in index 1 with a gain of 1 and lbs in index 2 with a gain of 2.2.

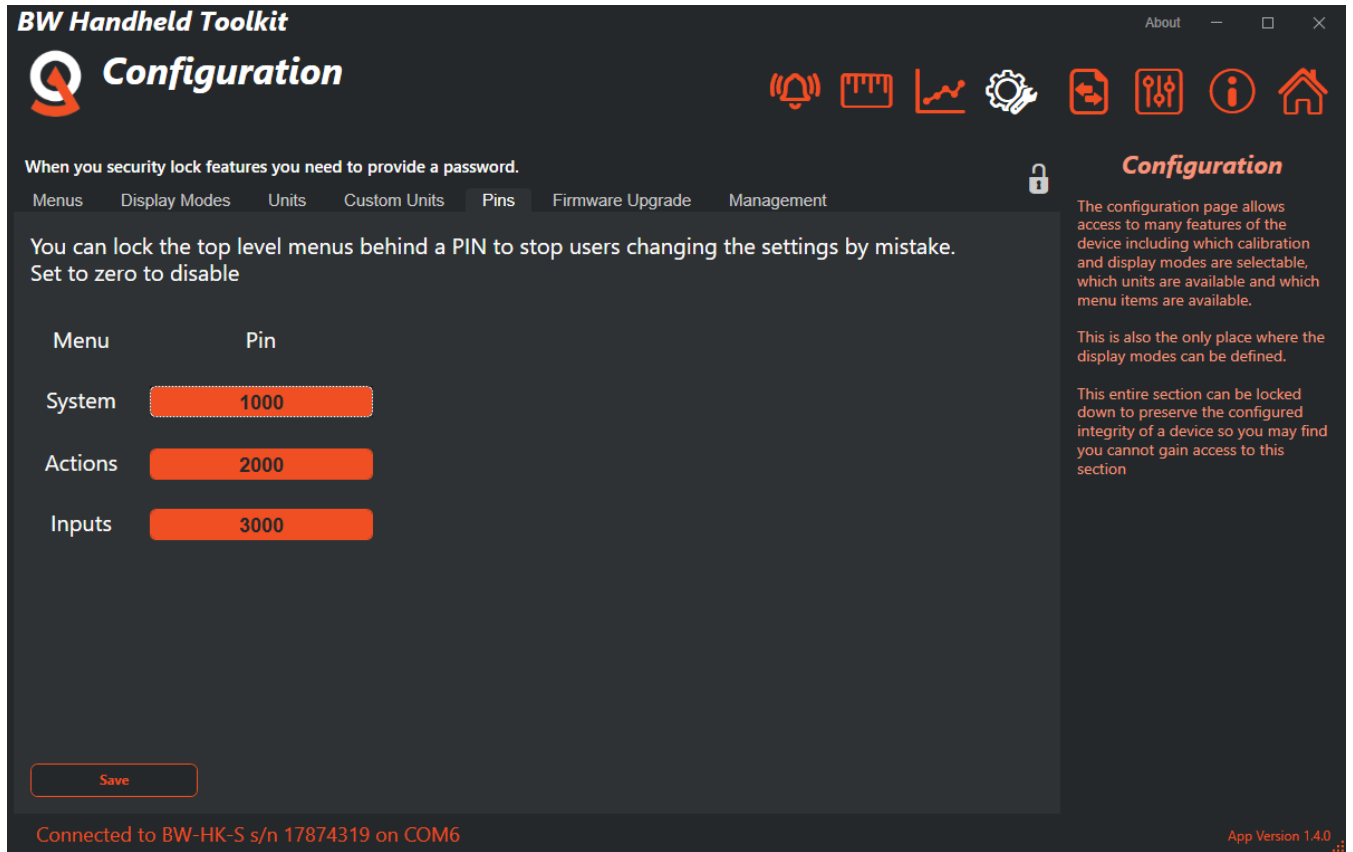

This tab allows the user to set up PINs that must be entered for the user to access the various menus. There is no PIN available to be set for the Info Menu as this is just for information and nothing can be changed by accident in there.

Item	Description
System entry field	Enter 4 digit number required for access to the System menu
Actions entry field	Enter 4 digit number required for access to the Actions menu
Inputs entry field	Enter 4 digit number required for access to the Inputs menu

Firmware Upgrade

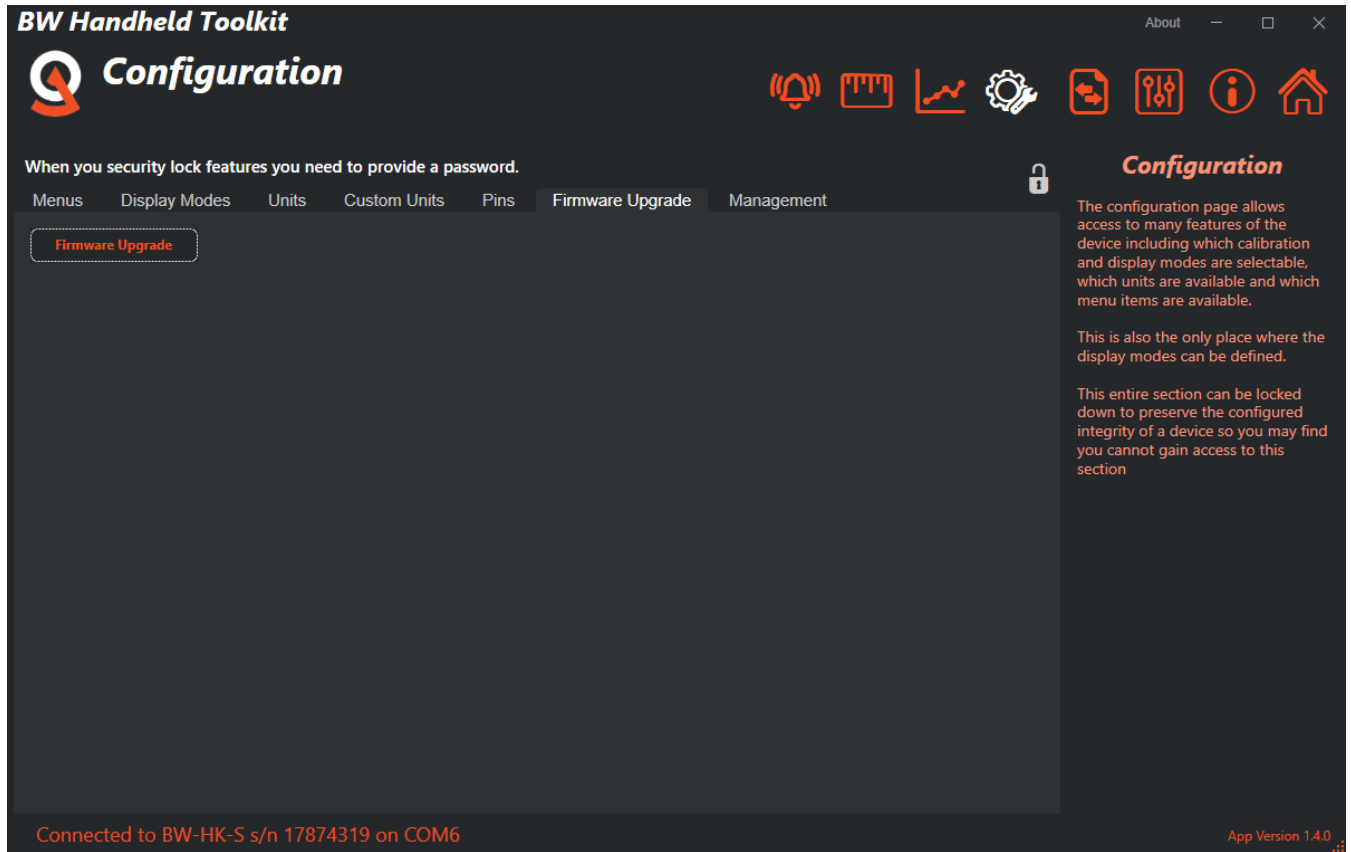

This tab allows the handheld's firmware to be updated if necessary.

The relevant upgrade file will be needed before carrying out this procedure.

i The toolkit must be launched using the 'Run As Administrator' option to enable firmware update to work.

i Do not remove power or USB while the handheld is being upgraded.

i The process will take approximately 60 seconds.

Item	Description
Firmware Upgrade button	Opens the upgrader window. Follow the instructions on screen

Management

This section allows access to passwords and hiding of menus.

Configuration

When you security lock features you need to provide a password.

Configuration password

New Password

Confirm Password

Clear Password

No Password Set

User Features

- Allow Firmware update
- Allow Key Actions Change

Configuration

The configuration page allows access to many features of the device including which calibration and display modes are selectable, which units are available and which menu items are available.

This is also the only place where the display modes can be defined.

This entire section can be locked down to preserve the configured integrity of a device so you may find you cannot gain access to this section

Connected to BW-HK-S s/n 17874319 on COM6

App Version 1.4.0

This tab lets the user change or remove the configuration password. The configuration password protects all the configuration pages and will hide any pages that are selected in Menu Protection below. It is also possible to allow firmware upgrade (when password protected) and allow key actions change.



There is no way to unlock a protected section if the password is forgotten! Resetting of a forgotten password will require proof of right to access and may require a return to supplier and incur additional cost.
DO NOT FORGET YOUR PASSWORD!

Item	Description
New Password entry field	Enter a new password
Confirm Password entry field	Confirm new password This must match the entry above
Set Password button	Click to set the password.
Clear Password entry field	If a password exists, click this button to remove it and to remove protection of the configuration settings.
Allow Firmware update switch	When set to off the user cannot upgrade the handheld firmware using the Configuration page when Configuration is locked with a password.
Allow Key Actions Change switch	When set to off the user cannot change the action assigned to the left, right, up and down keys on the Settings page.

When you security lock features you need to provide a password.

Configuration Inputs Menu Protection

Defined inputs password

New Password

Confirm Password

Clear Password

No Password Set

Configuration

The configuration page allows access to many features of the device including which calibration and display modes are selectable, which units are available and which menu items are available.

This is also the only place where the display modes can be defined.

This entire section can be locked down to preserve the configured integrity of a device so you may find you cannot gain access to this section

Connected to BW-HK-S s/n 17874319 on COM6

App Version 1.4.0

This tab lets the user change or remove the Inputs password. The Inputs password protects Define Inputs pages and relevant menus in the handheld.



There is no way to unlock a protected section if the password is forgotten!
 Resetting of a forgotten password will require proof of right to access and may require a return to supplier and incur additional cost.
DO NOT FORGET YOUR PASSWORD!

Item	Description
New Password entry field	Enter a new password
Confirm Password entry field	Confirm new password This must match the entry above
Set Password button	Click to set the password.
Clear Password entry field	If a password exists, click this button to remove it and to remove protection of the configuration settings.

BW Handheld Toolkit Configuration

When you security lock features you need to provide a password.

Menus Display Modes Units Custom Units Pins Firmware Upgrade Management

Configuration Inputs **Menu Protection**

Here we can restrict main menu entries available for user

- Actions
- Inputs
- Logging
- Configuration
- File
- Settings

Configuration

The configuration page allows access to many features of the device including which calibration and display modes are selectable, which units are available and which menu items are available.

This is also the only place where the display modes can be defined.

This entire section can be locked down to preserve the configured integrity of a device so you may find you cannot gain access to this section

Connected to BW-HK-S s/n 17874319 on COM6 App Version 1.4.0

This tab lets the user restrict access to the main menus in the toolkit if the configuration password is set.





To access any hidden toolkit pages the configuration password must be entered on the Information page

Item	Description
Actions switch	Show/Hide Actions page
Inputs switch	Show/Hide Define Inputs page
Logging switch	Show/Hide Logging page
Configuration switch	Show/Hide Configuration page
File switch	Show/Hide Import/Export page
Settings switch	Show/Hide Settings page

Logging

This page allows data from the handheld to be logged to a file and later reloaded to be viewed on the chart. A real-time chart is always visible whether logging is active or not.

Item	Description
Log Interval (ms) drop-down	Select the interval between logs in milliseconds. Choices are: <ul style="list-style-type: none"> 10 Log every 10 milliseconds. 100 times per second (100 SPS). 20 Log every 20 milliseconds. 50 times per second (50 SPS). 50 Log every 50 milliseconds. 20 times per second (20 SPS). 60 Log every 60 milliseconds. 16.6 times per second (16.6 SPS). 100 Log every 100 milliseconds. 10 times per second (10 SPS). 200 Log every 200 milliseconds. 5 times per second (5 SPS). 500 Log every 500 milliseconds. 2 times per second (2 SPS). 1000 Log every 1000 milliseconds. 1 per second (1 SPS).
Log File entry field	Double-click to select the folder and filename for the logged file.
Start Logging button	Start logging. You will be warned if the file already exists and given the option to continue or cancel the operation.
Source tick box	Select the source value to log.

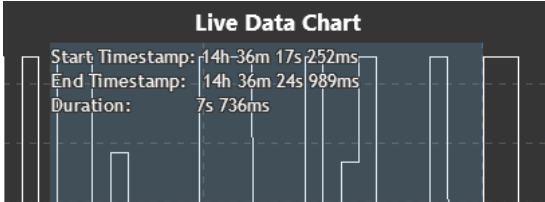
Chart chart	<p>The chart itself can be clicked on and supports the following actions:</p> <p>Zoom In Performed by clicking and dragging to draw a box over the portion of the chart to zoom in on. To zoom in the mouse must move to the right after clicking.</p> <p>Zoom Out Zoom back out to the full chart view by clicking and dragging to draw a box. The mouse must move to the left after clicking to zoom out.</p> <p>Free Zoom Use the mouse wheel to zoom in or out focused at the position of the mouse pointer.</p> <p>Scroll Vertically Click and drag the Y axis (Value). Only useful when Autoscale is off.</p> <p>Free panning Click and drag the chart using the right mouse button to pan around the data. Only useful when Autoscale is off.</p>
Pause icon	<p>Toggles between paused and running. When paused the chart data is not lost and the chart will be populated with missing data when resumed again.</p> <p> Click to pause chart.</p> <p> Click to resume chart.</p>
Autoscale switch	<p>Select whether to automatically scale the chart.</p> <p>Off Chart will not automatically scale to suit data as it is added. Click the Reset View button to perform a one off auto scale.</p> <p>On Chart will automatically scale to the data as it is added.</p>
Show Value switch	<p>Select whether to show information popup window as the mouse pointer hovers over data points</p> <p>Off Nothing is displayed.</p> <p>On Display pop-up information box showing the time and value of the data point under the mouse pointer.</p>
Measure Time switch	<p>Select whether to display the on chart tool for measuring the time between two horizontal points on the chart. This is made much easier if the chart is paused.</p> <p>Off Nothing is displayed.</p> <p>On The Measure Time tool is displayed. A vertical shaded box will appear and the sides can be dragged with the mouse to cover the desired part of the chart. The start and end timestamps along with the actual duration is then displayed.</p> 

<p>Measure Value switch</p>	<p>Select whether to display the on chart tool for measuring the value between two vertical points on the chart. This is made much easier if the chart is paused.</p> <p>Off Nothing is displayed. On The Measure Value tool is displayed. A horizontal shaded box will appear and the top and bottom can be dragged with the mouse to cover the desired part of the chart. The min and max values along with the actual difference between the two are displayed.</p> 
<p>Show Min/Max switch</p>	<p>Select whether to show lines to indicate the minimum and maximum value in the chart data.</p> <p>Off Nothing is displayed. On Min and max (Of the currently viewed data) lines are shown in red and green respectively.</p>
<p>Load Log File button</p>	<p>Opens a file dialog to allow you to select a previously logged data file. This file data will be loaded into the chart and can be viewed with all the tools available. The button caption will change to Back To Realtime Chart after the file has loaded.</p>
<p>Clear Chart button</p>	<p>Clear all data from the chart.</p>
<p>Reset View button</p>	<p>Returns the chart to its default view and zoom level after zooming or panning the chart.</p>
<p>Back To Realtime Chart button</p>	<p>This is what the caption of the Load Log File button changes to while a logged file is opened in the chart. Clicking the button will revert the chart to showing real-time data.</p>

Define Inputs

Define Inputs

The Define Inputs page allows you to set up the inputs for the handheld to display.

If you only wish to receive data from whichever T24 transmitters are around, set to roaming mode. You will then be able to display the first (number of inputs) transmitters that the device receives. Clear the list to rebuild. It is also possible to set global settings such as measurement units and overloads that will be applied to all inputs.

If you wish to define the inputs switch to defined mode. You can then define each input individually. Double click on the line that you wish to edit.

Each line then gives you live data from that input.

No	Data Tag	Flags	Value	Units	RSSI	CV	LQI
1	F5F3		0.417	kg	-22	107	100
2	D3E7		0.000	kg	-82	107	95
3	D3E8		0.000	kg	-82	106	90
4	AB43		0.352	kg	-95	99	40
5	0000						
6	0000						
7	0000						
8	0000						
9	0000						
10	0000						
11	0000						
12	0000						

Connected to BW-HK-S s/n 17874319 on COM6

App Version 1.4.0

This page allows configuration of the inputs that the handheld will display. It will also show the currently configured inputs and the data coming in for them

- If the Define Inputs password has been set you will not be able to configure the inputs, only change the settings along the top.
- Click the padlock to enter password and unlock.

Item	Description
Number of Inputs drop down	Select the maximum number of inputs to display (1-12)
Show Configured switch	Only show inputs that have been configured with a data tag
Mode drop down	Select between the two modes available Roaming The handheld will display data from the first (up to) 12 inputs that it receives. Global settings will be applied to all data coming in Defined Up to twelve inputs can be defined with individual settings for each input channel
Radio Channel drop down	Select the required radio channel (1-15) for the handheld This must match the transmitters
Group Key entry field	Enter the handheld Group Key for added security This must match any transmitters that need to be displayed
Save button	Apply the Group Key settings
Clear button	Only available in Roaming mode Clears the list and allows it to repopulate. Also issues a wake command
Wake All button	In Roaming mode, wakes all transmitters on same radio settings In Defined mode, wakes all transmitters on the list (if IDs are set)

Power on Wake switch	Wake when powered up. If only one channel is defined and the ID is set, the handheld will only try to wake that transmitter on power up. Otherwise, it will perform a broadcast wake. Also affects the action of the clear button in roaming. (available in v1.04 onwards)
Keep Awake switch	Enable for the handheld to keep all transmitters in the current list awake. (available in v1.04 onwards)
Power off Sleep switch	Enable for the handheld to sleep all transmitters in the current list on power down. (available in v1.04 onwards)
Sleep All button	Sleeps all transmitters in the list
Configuration button	Only available in Roaming mode (not available if inputs password is active) Allows editing of global settings to apply to all inputs

Roaming

The handheld is in Roaming mode by default. This allows the handheld to receive data from any transmitters on the same radio settings. The handheld can receive data from up to 12 transmitters. The list will be populated on a first come, first served basis. The list size can be reduced if required.

Configuration- Global

This page is visible after the Configure button has been clicked in Roaming mode

This allows adjustment to the global settings that will be applied to all roaming inputs.

Item	Description
Unit	
Unit Type drop down	Select the required unit type, eg mass or pressure Select disabled for no units to be shown. Only unit types that have been enabled in the Configuration tab will be available
Unit Name drop down	Select the required unit, eg kg or Pa Select disabled for no units to be shown. Only units that have been enabled in the Configuration tab will be available
Limits	
Warning entry field	If any incoming value is greater than this then the Warning Action will be triggered
Underload entry field	If any incoming value is less than this then the Underload Action will be triggered
Overload entry field	If any incoming value is greater than this then the Overload Action will be triggered
Display	
Timeout entry field	If the handheld has not received data from a transmitter for more than this time then a timeout will be triggered and '-----' will be shown
Resolution entry field	The resolution of the base units set above. The display will change in increments of this value
Zero Mask entry field	If the incoming value is less than this value then the display will show zero
Cancel button	Discard changes and close window
Save button	Save changes and close window

Defined

In defined mode the handheld can be set up with 1-12 fully configured inputs. Each input can have different settings depending on what data is coming in.

To access the setting for the individual inputs, double click the line in the table.

Configuration- General and Limits

Here you can adjust the display update rate and also scale the displayed data. This may be used, for example, to convert the data from a BW shackle calibrated in kg so that the handheld display shows lb.

Item	Description
Data Tag entry field	Data tag of the BW transmitter for this channel
ID entry field	ID for the incoming data for this channel, only required for targeted wake.
Name entry field	Name assigned to this input
Unit Type drop down	Select the required unit type, eg mass or pressure Select disabled for no units to be shown. Only unit types that have been enabled in the Configuration tab will be available
Unit Name drop down	Select the required unit, eg kg or Pa Select disabled for no units to be shown. Only units that have been enabled in the Configuration tab will be available
Limits	
Warning entry field	If incoming value is greater than this then the Warning Action will be triggered
Underload entry field	If incoming value is less than this then the Underload Action will be triggered
Overload entry field	If incoming value is greater than this then the Overload Action will be triggered
Cancel button	Discard changes and close window
Save button	Save changes and close window

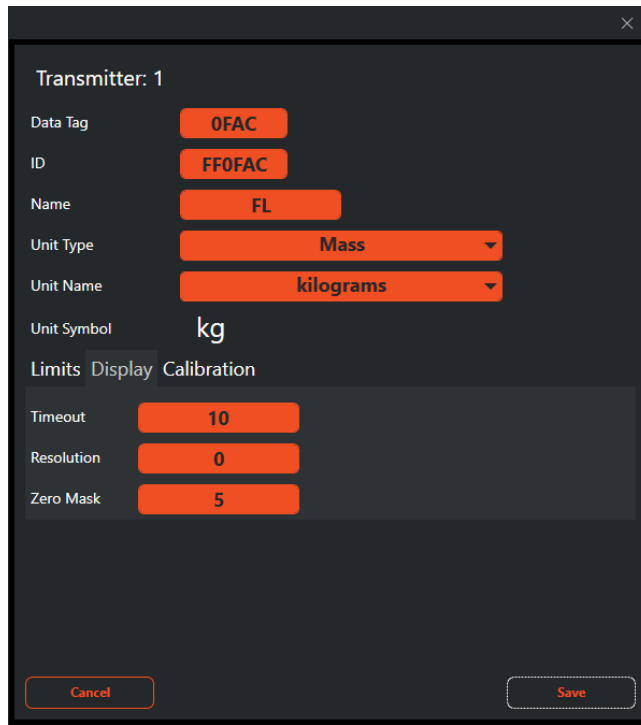

Item	Description
Data Tag entry field	Data tag of the BW transmitter for this channel
ID entry field	ID for the incoming data for this channel, only required for targeted wake.
Name entry field	Name assigned to this input
Unit Type drop down	Select the required unit type, eg mass or pressure Select disabled for no units to be shown. Only unit types that have been enabled in the Configuration tab will be available
Unit Name drop down	Select the required unit, eg kg or Pa Select disabled for no units to be shown. Only units that have been enabled in the Configuration tab will be available
Display	
Timeout entry field	If the handheld has not received data from the transmitter for more than this time then a timeout will be triggered and '-----' will be shown
Resolution entry field	The resolution of the base units set above. The display will change in increments of this value
Zero Mask entry field	If the incoming value is less than this value then the display will show zero
Cancel button	Discard changes and close window
Save button	Save changes and close window

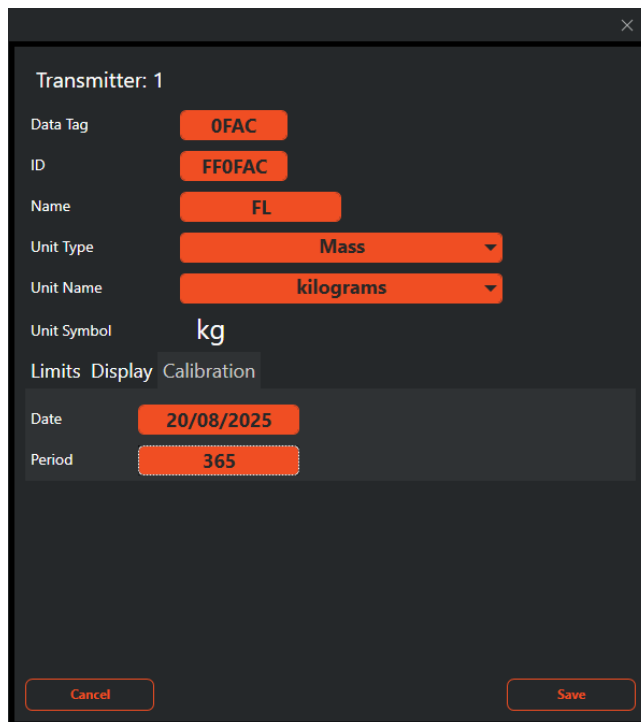

Item	Description
Data Tag entry field	Data tag of the BW transmitter for this channel
ID entry field	ID for the incoming data for this channel, only required for targeted wake.
Name entry field	Name assigned to this input
Unit Type drop down	Select the required unit type, eg mass or pressure Select disabled for no units to be shown. Only unit types that have been enabled in the Configuration tab will be available
Unit Name drop down	Select the required unit, eg kg or Pa Select disabled for no units to be shown. Only units that have been enabled in the Configuration tab will be available
Calibration	
Date entry field	Date that the transmitter was calibrated
Period entry field	Length of time in days that the calibration is valid for
Cancel button	Discard changes and close window
Save button	Save changes and close window

Actions

Actions defined for alarms

Action source: **Gross**

Action	Action Warning	Action Underload	Action Overload	Action Error
Beep	<input checked="" type="checkbox"/>	<input checked="" type="checkbox"/>	<input checked="" type="checkbox"/>	<input checked="" type="checkbox"/>
Vibrate	<input checked="" type="checkbox"/>	<input checked="" type="checkbox"/>	<input checked="" type="checkbox"/>	<input checked="" type="checkbox"/>
Flash Display	<input checked="" type="checkbox"/>	<input checked="" type="checkbox"/>	<input checked="" type="checkbox"/>	<input checked="" type="checkbox"/>
Full Screen Warning	<input checked="" type="checkbox"/>	<input checked="" type="checkbox"/>	<input checked="" type="checkbox"/>	<input checked="" type="checkbox"/>
Allow Snooze	<input type="checkbox"/>	<input type="checkbox"/>	<input checked="" type="checkbox"/>	<input type="checkbox"/>
Latched	<input checked="" type="checkbox"/>	<input checked="" type="checkbox"/>	<input checked="" type="checkbox"/>	<input checked="" type="checkbox"/>

Connected to BW-HK-S s/n 17874319 on COM6 App Version 1.4.0

This page allows setting of the Actions associated with the various limits and errors. It is possible to set different Actions for different error/warning states.

Item	Description
Action Source drop down	Select whether the limits are triggered by the gross or net values for each input
Action Warning, Underload, Overload, Error	
Beep switch	Beeping alert (does not need to be selected)
Vibrate switch	Vibrating alert (does not need to be selected)
Flash Display switch	Flashing Display alert The display of the input showing the error will flash
Full Screen Warning switch	Full Screen Alert A window pops up on screen when the error state is triggered
Allow Snooze switch	If allowed, it is possible to hide the Full Screen Warning for 60 seconds by clicking the Menu/OK button
Latched switch	When Latched, the error state will continue until it has been cleared in the menu

Enclosure & Mounting

See [Appendix A – Handheld Style](#) section for more information.

Antennas

These modules have a T24-ANTA fitted inside the enclosure.

Specification- BW-HK-S

Electrical	Min	Typical	Max	Units
Power Supply voltage		3.0		Vdc

Power Supply	Min	Typical	Max	Units
Active		50		mA
Standby		120		µA
Estimated Battery life using 2Ahr batteries:				
Standby mode (Powered off)		1.5		Years
Continuous operation		40		Hours

Environmental	Min	Typical	Max	Units
IP rating		IP67		
Operating Temperature Range	-10		+50	C
Storage Temperature	-20		+80	C
Humidity	0		95	%RH

Physical	
Hand Held Dimensions	93 mm x 156 mm x 40 mm
Screen size	68 mm x 34 mm (128 x 64 pixels)

Radio Range

To determine radio range please refer to [Appendix B – Antenna Range](#)

BW-HR

Overview

The BW-HR is a roaming handheld that can be used to view the reading supplied by an unlimited number of Broadweigh shackles. The shackle module Data Tags or IDs do not need to be known beforehand.

The handheld will automatically wake any shackle on the same channel and group key.

An internal list is maintained of the top n number of transmitter modules ordered by signal level and a **Next** key on the handheld allows cycling through this list.

The list size (n) is variable between 2 and 20 and this enables the viewing experience to be tailored to particular applications.

The transmitter modules are identified by their 4 character hexadecimal Data Tags and these may be set using the Broadweigh Toolkit.

When in communication with a particular shackle the LED on that shackle is activated. This provides visual feedback of the selected and currently viewed shackle.

i Although the handheld will wake up sleeping Transmitter modules as it detects them it will not send them back to sleep. After the handheld is turned off the Transmitters will remain awake. Use Sleep Delay setting in Transmitters to ensure they turn off again when the handheld is turned off or moves out of range.

Order Codes

BW-HR



Handheld display for unlimited number of shackles in a robust weatherproof enclosure.

Connections

Power

The handheld module is powered by two alkaline AA batteries.



Due to the higher voltage requirements of this module NiMh and NiCad batteries are not recommended.

Operation

View readings

Turn the handheld on by pressing and holding the  symbol (on the right) until the display is active. This will wake the radio and measurement system in the Broadweigh shackle(s). The factory default displayed value is in kg.

The handheld display automatically switches 'on' the shackles as soon as they are in range. The handheld will then display the shackle with the strongest signal – in most cases the nearest shackle.

Select a new shackle to display by pressing the  key and the shackle data tag will be shown briefly before the reading is displayed. The data tag is (by default) the last 4 characters of the ID which can be found on the shackle label.

By pressing and holding the  key, the shackle Data Tag currently being measured will be shown.

The currently selected shackle LED will also change from flashing to permanently on.

The handheld can read from an unlimited number of shackles.

The Broadweigh shackles is pre-set to return to sleep 60 seconds after the handheld is turned off or is taken out of range.

 **TIP!** – The Broadweigh Shackle Data Tag can be changed to an easily remembered 4 digit hexadecimal code to reflect its position within your system. For example 'A001'. See Broadweigh Shackle – [Advanced settings](#).

Keys



Power Key - Press and hold the power key for approximately 2 seconds then release the key.

This will toggle between turning the handheld on and off.

Can also be used, by giving a quick press, to reset the Auto-Sleep delay.



Next Key - Selects the next shackle to view.

Pressing and holding will display the currently viewed module Data Tag without moving to the next module.

Indicators

SIG LOW

The radio signal from the shackle is low. The shackle is still functioning but the limit of the range may be near. Communications may start to deteriorate when this indicator is visible. Until ----- is displayed the communications is still OK and the display can be relied on for accuracy.

 Even with a degraded signal the display value will always be correct.

BATT LOW

The batteries in the handheld are low and need to be replaced.

REMOTE ERROR

The shackle has an error that the handheld does not recognise.

REMOTE BATT LOW

The battery in the shackle is low.

Errors

Displayed on handheld LCD.

- Error 1** The shackle is in shunt calibration mode. An external module or software may have placed the shackle in Shunt Calibration mode so rather than display a misleading reading this error is displayed instead.
- Error 2** Input integrity error. The shackle module has found a problem with the input. There may be open or short circuits. Rather than display a misleading reading this error is displayed instead.
- Overload** The overload limit set by the user has been exceeded.

Special Modes

Pair



The handheld has the ability to configure a shackle to match the handheld's own radio channel and group key settings.

Ensure that the transmitter module is unpowered for at least 10 seconds. Locate the upper left key by feeling for a slight bump on the label.

Press and hold this key for 5 seconds until PAIRING appears on the LCD. Release the key and apply power to the shackle.

The amount of time you have to reapply power to the transmitter module can be set by **PairDuration** in the Broadweigh Toolkit when connected to the BW-HR. This defaults to 5 seconds.

System Zero



The handheld has the ability to perform a system zero on a shackle. This may be useful after installing new shackles and enables system zero to be set without the need for a PC/laptop and Broadweigh Toolkit.

Set the handheld to view the desired shackle by using the Next key.

Locate the upper right key and lower right key by feeling for slight bumps on the label.

Press and hold these keys for around 8 seconds until ZERO appears on the LCD. Release the keys and the display should then show the zeroed reading.

This system zero is performed at the shackle and is stored through power cycling.



You cannot remove a system zero using this function. You can only re-zero.

To remove a system zero you must pair to the shackle using the Toolkit and remove it from there.

Configuration

Launch the Broadweigh Toolkit software application and pair to this module to enable the connection to the Toolkit to allow configuration to take place. See [Common Toolkit Pages - Home](#)

Display Format



Here you can adjust the display.

Items you can change:

- | | |
|--------------------------|---|
| Format & Resolution | <p>Here you can define how the values are displayed on the LCD. There are 7 digits available and you can define where the decimal point is shown by entering text where a zero indicates a numeric digit position.</p> <p>When the data is being displayed the number of decimal places you define may be overridden as the display will always show the correct number of integer digits.</p> <p>Example: If you set the format to 000.0000 and the value to display is 1000.1234 the display will show 1000.123</p> <p>You can also define the resolution, which is the block size of changes to the display.</p> <p>Example: If you enter the format as 000.0005 the display will only change in steps of 0.0005 which can be used to mask noisy digits at high resolutions.</p> |
| Leading Zero Suppression | <p>This can be turned on or off and will suppress leading zeroes when on.</p> <p>Example: If the display reads 000.123 with leading zero suppression turned off it will display 0.123 when turned on.</p> |
| Overload Limit | <p>You can enter a limit here above which Overload will be shown on the display instead of the actual value.</p> <p>Enter zero to disable this feature.</p> |

Timeout

Enter the timeout in seconds. This sets the time allowed without any data arriving from the viewed module before all dashes are displayed on the LCD. Should be at least 3 times the interval between the messages being sent by the transmitter module.



You should not normally need to change these settings.

Items you can change:

List Size

This setting determines how many of the transmitter modules with the highest signal level make up the list which the next key cycles around.

Based on the application and how many transmitter modules are in the vicinity of the handheld this list size can affect how the operator uses the handheld.

Range is between 2 and 20.

Auto Off Delay

Here you can specify the delay in minutes after which the handheld will automatically turn off after no button is pressed.

Enter zero to disable this function. The default is 5 minutes.

Enclosure & Mounting

See [Appendix A – A Type](#) section for more information.

Antennas

These modules have the antenna already fitted inside the enclosure so there are no specific mounting requirements.

Specification

Electrical	Min	Typical	Max	Units
Power Supply voltage	2.5	3.0	3.6	Vdc

Power Supply	Min	Typical	Max	Units
Active		35	40	mA
Low power mode		120	160	µA
Estimated Battery life using 2Ahr batteries:				
Standby mode (Powered off)		1.5		Years
Continuous operation		40		Hours

Environmental	Min	Typical	Max	Units
IP rating		IP67		
Operating temperature range	-10		+50	°C
Storage temperature	-40		+85	°C
Humidity	0		95	%RH

Physical				
Hand Held Dimensions			90 x 152 x 34 mm	

Radio Range

For details of radio range please refer to [Appendix B – Radio Range](#)

BW-HA

Overview

The BW-HA is a highly configurable handheld display for displaying data from Broadweigh shackles and other transmitters. The handheld can operate by displaying data from any transmitter detected or you can define up to 24 specific shackles or other transmitters to allow the operator to cycle through.

Grouping functions allows up to 8 group totals to be viewable. Each group or individual transmitter has user defined name, scaling, display format, zero functions and overload settings.

Order Codes

BW-HA



Handheld display module in a robust weatherproof enclosure.

Connections

Power

The handheld module is powered by two alkaline AA batteries.

i Due to the higher voltage requirements of this module NiMh and NiCad batteries are not recommended.

Quick Start

This section will show you how to get the handheld and a Transmitter working out of the box. You will require two AA batteries for the handheld and a 3 V dc supply for the transmitter module which may also be a pair of AA batteries.

Connecting Power

BW-HA

Remove the two screws on the rear battery compartment. Insert two AA batteries. Refit the battery compartment cover. The handheld module is now switched on and will display **BUSY** until it detects a Transmitter.

Shackle or Transmitter Module

See the relevant shackle or transmitter module manual section for information about connecting power.

Viewing Shackle or Other Transmitter Data

The factory default setting for the handheld is that no specific Transmitter modules are configured so it will display data from any Transmitter on the same radio channel and using the same Group Key. If you have purchased the handheld and Transmitter module (or shackle) at the same time then both will default to radio channel 1 and a blank Group Key. Once power has been applied to the Transmitter the handheld will briefly display its Data Tag then show its value on the LCD. If you have more than one Transmitter then pressing the Next key (Triangular arrow) will move to the next available Transmitter.



Note that when no Transmitters are specified as inputs the handheld will wake up sleeping Transmitter modules as it detects them but it will not send them to sleep. After the handheld is turned off the Transmitters will remain awake. Use Sleep Delay setting in Transmitters to ensure they turn off again when the handheld is turned off or moves out of range.

Operation

Keys

The keys have two functions. A short press is a press and release. A long press is press and hold for around 2 seconds.



Power Key

Long Press – Powers the handheld on and off. Hold the power key until the display shows BUSY then release the key.

Quick Press - Toggle the backlight on and off when in manual backlight mode.



Next Key

Short Press - Step to the next Transmitter or group. A brief prompt will be displayed before the value is shown which will either be the Transmitter Data Tag or a user defined name.

Long Press - Display the Data Tag or name of the currently viewed Transmitter or group without moving to the next.



Tare Key

Short Press - This will toggle between gross and zeroed net mode. i.e. If the display shows gross then pressing the key will zero the display. Pressing the key when in net mode will return the display to gross mode. The Gross and Net modes are indicated as described below. Gross and Net states are retained through power off.

Long Press - When in net mode will briefly display the Gross value but remain in net mode.

Indicators



The display is showing Gross weight.



The display is showing Net weight.



The radio signal from the transmitter module is low. The module is still functioning but the limit of the range may be near. Communications may start to deteriorate when this indicator is visible. Until ----- is displayed the communications are still OK and the display can be relied on for accuracy.



Even with a degraded signal the display value will always be correct.



The batteries in the handheld are low and need to be replaced.

REMOTE



The transmitter module has an error that the handheld does not recognise.



The battery or supply to the transmitter module is low.

Errors

Displayed on handheld LCD.

Error 1

The transmitter module has a strain gauge input and is in shunt calibration mode. An external module has placed the transmitter module in Shunt Calibration mode so rather than display a misleading reading this error is displayed instead.

Only certain transmitters support this error type.

Error 2

Input integrity error. The transmitter module has found a problem with the input. There may be open or short circuits. Rather than display a misleading reading this error is displayed instead.

Only certain transmitter modules support this error such as the shackles.

Overload

The overload limit set by the user has been exceeded.

Configuration

The Broadweigh Toolkit provides a means of simple configuration of the handheld module along with useful tools to aid integration.

Launch the Broadweigh Toolkit software application and pair to this module to enable the connection to the Toolkit to allow configuration to take place.

Remove a handheld battery, click Pair in the Toolkit and replace battery to perform a full pairing. This will work regardless of the radio settings in either the base station or the handheld.

If you know that the radio channel and group key settings of the base station and the handheld are the same you could soft pair to the handheld by performing a manual pair in the Toolkit and just entering the ID of the handheld.

[See Common Toolkit Pages - Home](#)

Modes of Operation

The handheld will allow you to view data from multiple transmitters and also allow the viewing of the sum of multiple transmitters. How the handheld operates depends on how you configure its list of transmitters ('Inputs') and optional summing groups.

When the handheld is turned on it will wake all transmitters using the same radio channel and group key if you have selected this feature.

No List Entered (Default)

In its simplest, out of the box, configuration the handheld has no transmitter inputs specified. In this mode the handheld will display data from any transmitter using the same radio channel and group key. To make things easier you can set a list Set Size so that the Next key just cycles around the n highest signal transmitters. This has a useful effect when setting the list size to 1 in that you can walk up to a transmitter, press the Next key and effectively select that one for viewing (as that will be the highest signal transmitter detected). As the different transmitters are cycled through, their Data Tags will be displayed briefly before their transmitted value is shown. In this mode the transmitters should have their Sleep Delay settings enabled so that they go back to sleep after the handheld is turned off or out of range as the handheld will wake all transmitters but not send them back to sleep. (Equivalent to the roaming capability of the BW-HR handheld)

List Entered

When you know which transmitter or transmitters are in your system (or you want to limit viewing to a certain collection of transmitters) you can enter up to 24 in the handheld's list of transmitters. The advantage over *not* having a list is that you can name each transmitter so their name is shown on the display instead of their Data Tag as they are selected. You can also configure each input separately for overload, format and scaling etc.

In this mode, if the option to sleep and wake transmitters is enabled, the transmitters will be sent to sleep when the handheld is turned off.

List Entered Plus Summing Groups

Once you have entered at least one transmitter input in the list you also have the option of creating summing groups. Up to eight groups can be defined and any of the inputs can be defined as belonging to any of the groups. In this mode the Next key cycles around the groups instead of the individual inputs. Each summing group will display the summed total of all its constituent inputs. Groups have user defined names as well as overload levels, scaling and formats. Unless disabled you can also 'drill down' and look at the groups constituent inputs.

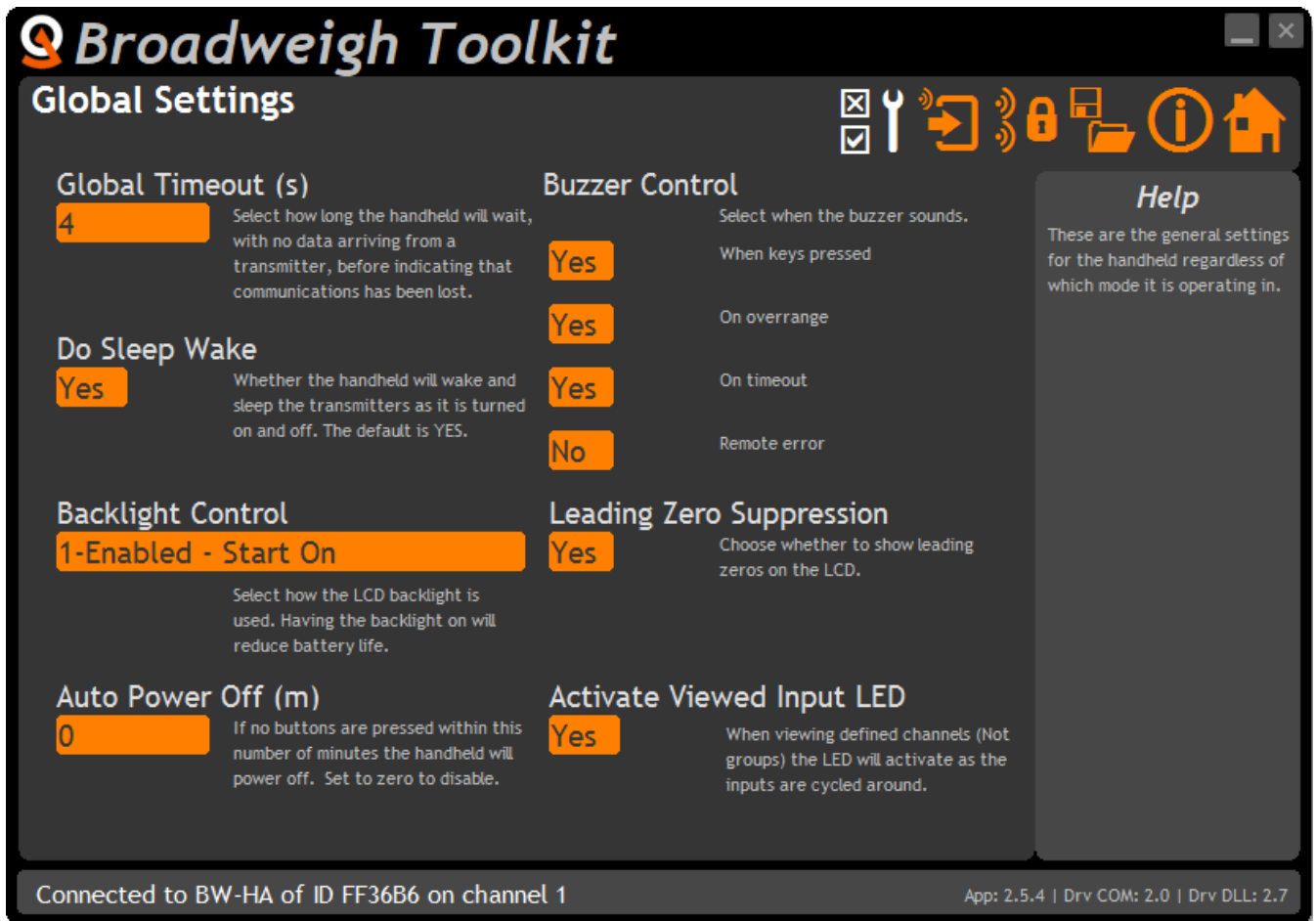

Here you can adjust the settings common to all modes of operation.

Items you can change:

- Global Timeout (s)** This is how long the handheld will wait with no data received from the viewed transmitter before indicating that the signal has been lost. This should be set to at least twice the slowest transmitter interval.
- Do Sleep Wake** Select this feature to enable the handheld to wake and sleep transmitters. When no transmitters are defined all sleeping transmitters (on the same radio channel and using the same Group Key) will be woken as they come into range of the handheld. Transmitters will not be sent to sleep regardless of this setting.
 When transmitters have been defined the handheld operated a little differently. For the first 12 seconds after turning the handheld on **all** transmitters will be woken (not only those defined). But on turning off the handheld the transmitters in the list will be sent to sleep.
- Backlight Control** Select whether to disable or enable the backlight. If enabled you can chose to turn it on as soon as the handheld turns on and have control over its state using the power key (short press) or you can choose to operate automatically whereby the light comes on when a key is pressed and goes off after 30 seconds.
- Auto Power Off** Set a time in minutes after which the handheld will turn off if no keys have been pressed. Set to zero to disable this feature. Will require a power cycle to change.
- Buzzer Control** Here you can select whether the buzzer will sound when certain states are active.
- Leading Zero Suppression** This will remove leading zeros from displayed values in all modes.

Activate Viewed Input
LED

When no transmitters are defined the transmitter currently being viewed will always activate its LED regardless of this setting. When any transmitters are defined then the transmitters LEDs will only activate when being viewed if this setting is activated.



This feature should be disabled when being used with shackles with firmware versions below 04.00 as their LEDs may remain on when turning off the handheld.

Configure Inputs

No Defined Transmitters

This page will be displayed when no transmitter list has been defined.

Broadweigh Toolkit

Configure Inputs

Current Mode: No inputs defined. Handheld can display data from any transmitter.

The handheld can operate in two modes. If you choose to define up to 24 transmitters you can set the format, scaling and overload for each individual channel and set name to display as each input is selected. You can also take advantage of summed groups which can sum the outputs of any combination of defined transmitters. Or you can choose to not define any transmitters and allow the handheld to view any transmitters on the same radio channel and using the same group key. Currently there are no transmitters defined so anything the handheld displays will use the settings below.

Set Size 3
You can choose the size of the transmitter set to scroll through when the 'Next' button is pressed. The handheld will keep a dynamic list, of the chosen size, of the highest power transmitters detected. This just limits the scrollable set to a manageable number when a lot of transmitters are present. For example: Set the size to 1 to enable the ability to walk up to a transmitter and click 'Next' to view that transmitter.

Format & Resolution 000.00
Set the format and resolution for all displayed values.

Overload 200.0
Set the overload level above which 'Overload' will be displayed.

Zero Indication Band 0.0
If the absolute value to display is less than this level then zero will be displayed.

Define Transmitters
If you want to define one or more transmitters click the 'Define' button.

Help
This page allows you to define up to 24 transmitters as selectable inputs with individual control over format, resolution, and scaling. You can also supply a name to display as each input is selected.
You can optionally define up to 8 summing groups which are displayed instead of the individual inputs. These groups allow any number of inputs to be summed and you also have control over the name, format and scaling of those groups.

Connected to BW-HA of ID FF36B6 on channel 1
App: 2.5.4 | Drv COM: 2.0 | Drv DLL: 2.7

Here you can adjust the settings common to all displayed transmitter values.

Items you can change:

- Set Size** This setting determines how many transmitter modules, with the highest signal levels, make up the set through which the Next key cycles. Based on the application and how many transmitter modules are in the vicinity of the handheld this list size can affect how the operator uses the handheld. See [Example Configuration Scenarios](#)
- Format & Resolution** Here you can define how the values are displayed on the LCD. There are 7 digits available and you can define where the decimal point is shown by entering numerals where a zero indicates a numeric digit position. When the data is being displayed the number of decimal places you define may be overridden as the display will always show the correct number of integer digits. Example: If you set the format to 000.0000 and the value to display is 1000.1234 the display will show 1000.123
You can also define the resolution, which is the block size of changes to the display. Example: If you enter the format as 000.0005 the display will only change in steps of 0.0005 which can be used to mask noisy digits at high resolutions.

Zero Indication Band	<p>Using this setting you can mask tiny changes in input after you press the Tare button. Entering zero will disable this function. Entering a non-zero value will provide a band within which the display will always read zero. Once the reading exceeds this value the real weight will be displayed as no taring is taking place.</p> <p>Example: You are adding boxes to a platform and you press tare between adding each one so you can see the weight of each box. Without this setting activated each time you tare the display will be around zero but not exactly zero (By setting the display resolution you may also hide this difference) by setting a small value here such as 0.2kg the display will show a stable zero while actual weight is fluctuating less than ± 0.2kg.</p>
Overload	<p>You can enter a limit here above which 'Overload' will be shown on the display instead of the actual value. Applies to the gross input value including any custom scaling. Enter zero to disable this feature.</p>
Define Transmitters	<p>Click the 'Define' button to display the page that allows you to define Transmitters.</p>

Defined Transmitters

These pages will be displayed when at least one Transmitter has been defined or you click the 'Define' button on the page shown when no transmitters are defined (See previous page).

General Tab

Broadweigh Toolkit

Configure Inputs

Current Mode: Inputs have been defined. No groups are defined so handheld will display data from defined transmitters.

You can assign up to 24 inputs simply by specifying the Data Tag of the relevant transmitters.

1 2 3 4 5 6 7 8 9 10 11 12 13 14 15 16 17 18 19 20 21 22 23 24

General Zero Scaling Group Membership

Set the general settings for this input.

Data Tag
4D0B Set the Data Tag for this input. Set to nothing to disable.

Name
Front L Select a name to display when this input is selected. Setting blank will default to 'Inp xx'

Format
000.0 Set the format and resolution of the displayed value for this input.

Overload
1000.0 Set the overload value for this input. 'Overload' will be displayed when exceeded.

Switch Back To Roaming Mode
To operate in roaming mode where the data from any transmitter can be displayed you need to remove all assigned inputs. You can do this manually by setting all Data Tags to nothing or click the button. **Clear All**

Help
This page allows you to define up to 24 transmitters as selectable inputs with individual control over format, resolution, and scaling. You can also supply a name to display as each input is selected.
You can optionally define up to 8 summing groups which are displayed instead of the individual inputs. These groups allow any number of inputs to be summed and you also have control over the name, format and scaling of those groups.

• Connected to BW-HA of ID FF36B6 on channel 1 App: 2.5.4 | Drv COM: 2.0 | Drv DLL: 2.7

Here you can adjust the general settings for the selected Transmitter input. Select the required input by clicking the numbered tabs along the top of the page.

Items you can change:

- Data Tag** By entering a Data Tag you enable this Transmitter Input. Enter zero to disable this input. You can enter Data Tags in any of the 24 available slots. The Next button will just cycle between those entered.
- Name** As you cycle between available transmitters with the Next key an identifier is shown briefly before the value is displayed. If you enter text here then this will be shown but if you leave this blank the Data Tag will be shown.
Some letters cannot be displayed on a 7 segment LCD digit. You cannot use letters M, W or K. Some letters will look alike. i.e. Z and 2. The LCD Preview will show how the entered name will look on the display.

Format	<p>Here you can define how the values are displayed on the LCD. There are 7 digits available and you can define where the decimal point is shown by entering numerals where a zero indicates a numeric digit position.</p> <p>When the data is being displayed the number of decimal places you define may be overridden as the display will always show the correct number of integer digits.</p> <p>Example: If you set the format to 000.0000 and the value to display is 1000.1234 the display will show 1000.123</p> <p>You can also define the resolution, which is the block size of changes to the display.</p> <p>Example: If you enter the format as 000.0005 the display will only change in steps of 0.0005 which can be used to mask noisy digits at high resolutions.</p>
Overload Limit	<p>You can enter a limit here above which 'Overload' will be shown on the display instead of the actual value. Applies to the gross input value including any custom scaling.</p> <p>Enter zero to disable this feature.</p>
Switch Back to Roaming Mode	<p>Click the 'Clear All' button to remove all of the transmitters and group settings to return to the roaming mode with no transmitters defined.</p>



The changes you make are not saved to the handheld until you click on a new input tab or select another page to view.

Broadweigh Toolkit

Configure Inputs

Current Mode: Inputs have been defined. No groups are defined so handheld will display data from defined transmitters.

You can assign up to 24 inputs simply by specifying the Data Tag of the relevant transmitters.

1 2 3 4 5 6 7 8 9 10 11 12 13 14 15 16 17 18 19 20 21 22 23 24

General Zero **Scaling** Group Membership

This allows you to set the zero characteristics for the selected input.

Power On Zero
0.0 If, on turning on the handheld, the value of this input is less than the specified value then it will be zeroed.

Zero Indication Band
0.0 Set a value below which the input will be displayed as zero.

Switch Back To Roaming Mode
To operate in roaming mode where the data from any transmitter can be displayed you need to remove all assigned inputs. You can do this manually by setting all Data Tags to nothing or click the button. **Clear All**

Help
This page allows you to define up to 24 transmitters as selectable inputs with individual control over format, resolution, and scaling. You can also supply a name to display as each input is selected.
You can optionally define up to 8 summing groups which are displayed instead of the individual inputs. These groups allow any number of inputs to be summed and you also have control over the name, format and scaling of those groups.

Connected to BW-HA of ID FF36B6 on channel 1 App: 2.5.4 | Drv COM: 2.0 | Drv DLL: 2.7

Here you can configure the zero settings for the selected Transmitter input.

Items you can change:

- | | |
|-----------------------------|---|
| Power On Zero | Here you can determine whether the BW-HA performs automatic zero when it is powered on.
Enter zero to disable this function.
If you enter a non-zero value then when the handheld is first turned on it checks the value read from the transmitter module. If this falls within \pm of this value then the display will be altered so this reads zero. |
| Zero Indication Band | Using this setting you can mask tiny changes in input after you press the Tare button or are close to zero in gross mode.
Entering zero will disable this function.
Entering a non-zero value will provide a band within which the display will always read zero. Once the reading exceeds this value the real weight will be displayed as no taring is taking place. |
| Switch Back to Roaming Mode | Click the 'Clear All' button to remove all of the transmitters and group settings to return to the roaming mode with no transmitters defined. |



The changes you make are not saved to the handheld until you click on a new input tab or select another page to view.

Here you can configure the scaling for the selected Transmitter input.

Use the Gain and Offset to manipulate the input value. This can perform quite a few useful functions such as:

Zero an Input – If a particular Transmitter value has a value that you want to remove but do not want to perform a system zero at the transmitter end you can use the Offset to remove that value. Setting the Offset to 10 will remove 10 from the transmitted value.

Convert Units – If the transmitter was calibrated in kg and you wish to display the value in lbs you can set a Gain of 2.20462 and an Offset of 0.0

Change Polarity – If the Transmitted value was negative but you wanted to display a positive value set the Gain to -1.0 and the Offset to 0.0



Actual Displayed Value = Transmitted Value * Gain - Offset

Items you can change:

- | | |
|-----------------------------|--|
| Gain | This value will be multiplied by the transmitted value to provide the actual displayed value. The default is 1.0 |
| Offset | This offset will be applied to the transmitted value (After gain is applied) to provide the actual displayed value. The default is 0.0 |
| Switch Back to Roaming Mode | Click the 'Clear All' button to remove all of the transmitters and group settings to return to the roaming mode with no transmitters defined. |

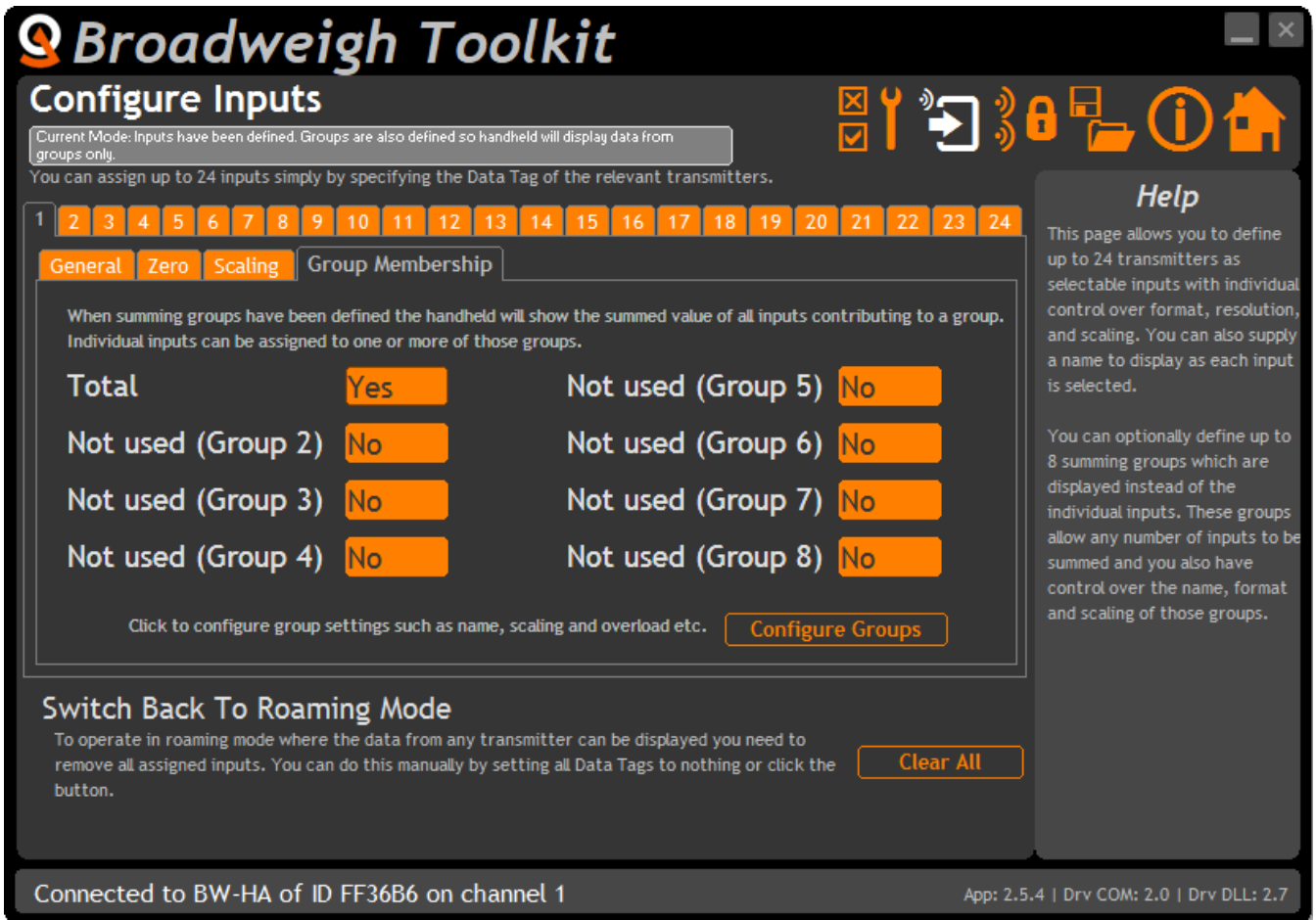

Here you can assign the selected Transmitter input to belong to any of the Summing Groups.

Items you can change:

- 8 Available Summing Groups The 8 available Summing Groups are shown here regardless of whether a group has been defined or not. Simply select Yes or No to indicate whether this Transmitter Input will contribute to that group’s total value.
- Configure Groups Button Clicking this button will open the [Summing Groups](#) page.
- Switch Back to Roaming Mode Click the ‘Clear All’ button to remove **all** of the transmitters and group settings to return to the roaming mode with no transmitters defined.

i The changes you make are not saved to the handheld until you click on a new input tab or select another page to view.

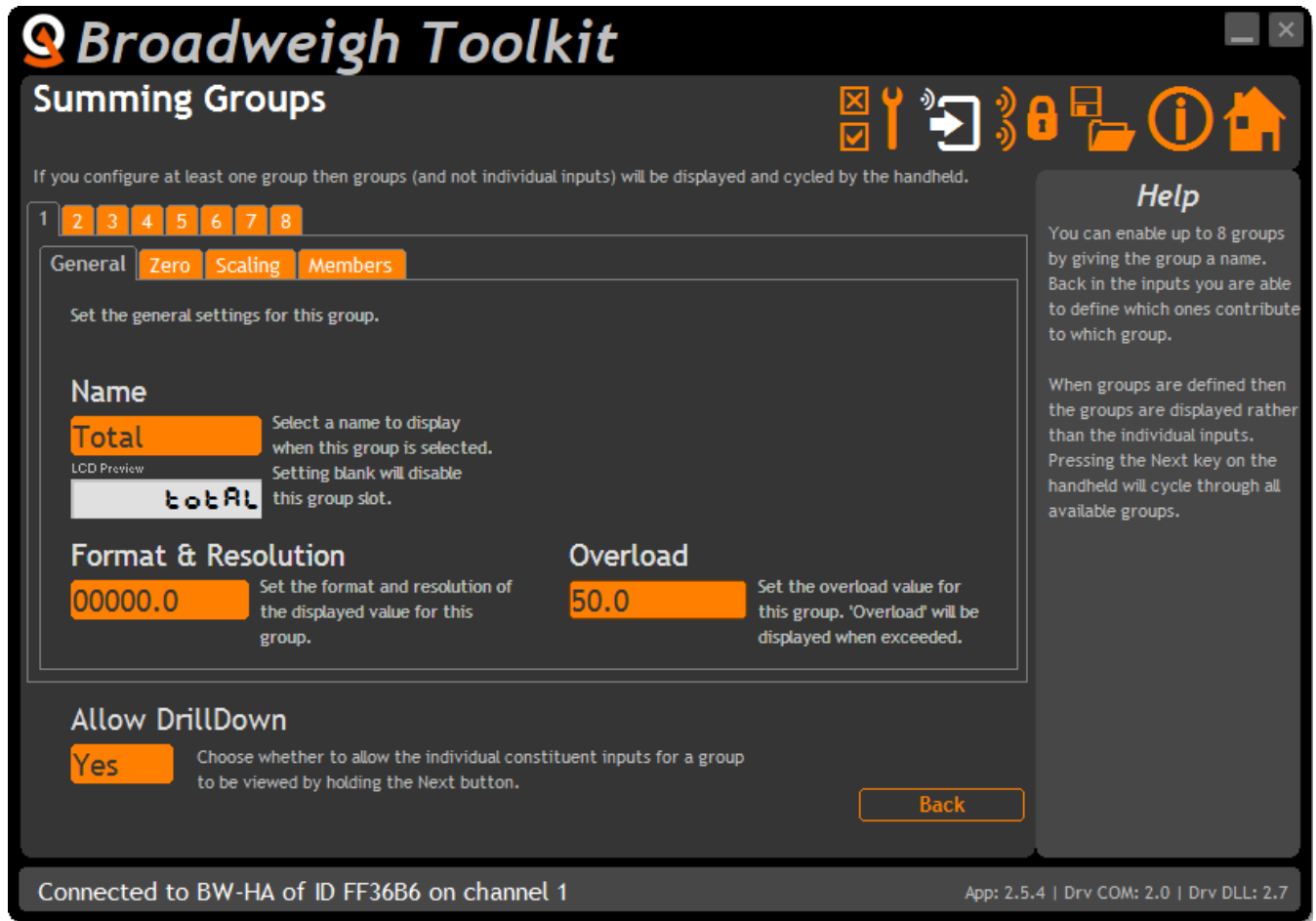

Here you can configure general settings for the selected Summing Group. Select the group by clicking the numbered tabs along the top of the page.

! As soon as at least one Summing Group has been enabled (By naming it) then the handheld will only cycle through the Summing Groups instead of the individual inputs. The values shown will be the sum of all the individual inputs that are members of that group.

Items you can change:

Name Summing Groups are enabled by giving them a name. Leave the name blank to disable the selected group.
 As you cycle between group totals with the Next key an identifier is shown briefly before the total is displayed.
 Some letters cannot be displayed on a 7 segment LCD digit. You cannot use letters M, W or K. Some letters will look alike. i.e. Z and 2. The LCD Preview will show how the entered name will look on the display.

Format & Resolution	<p>Here you can define how the values are displayed on the LCD. There are 7 digits available and you can define where the decimal point is shown by entering numerals where a zero indicates a numeric digit position.</p> <p>When the data is being displayed the number of decimal places you define may be overridden as the display will always show the correct number of integer digits.</p> <p>Example: If you set the format to 000.0000 and the value to display is 1000.1234 the display will show 1000.123</p> <p>You can also define the resolution, which is the block size of changes to the display.</p> <p>Example: If you enter the format as 000.0005 the display will only change in steps of 0.0005 which can be used to mask noisy digits at high resolutions.</p>
Overload	<p>You can enter a limit here above which 'Overload' will be shown on the display instead of the actual value. Applies to the gross input value including any custom scaling.</p> <p>Enter zero to disable this feature.</p>
Allow Drilldown	<p>When at least one Summing Group has been named the Next key will cycle through group totals rather than individual inputs.</p> <p>If you allow drilldown then holding the Next key for a long press will start to display the individual inputs that are members of the group. Each press of the Next key will show the next input in the group. After the last input has been shown the display will revert back to displaying the groups again.</p>
Back Button	<p>Click the 'Back' button to display the Transmitter Inputs pages again.</p>



The changes you make are not saved to the handheld until you click on a new input tab or select another page to view.

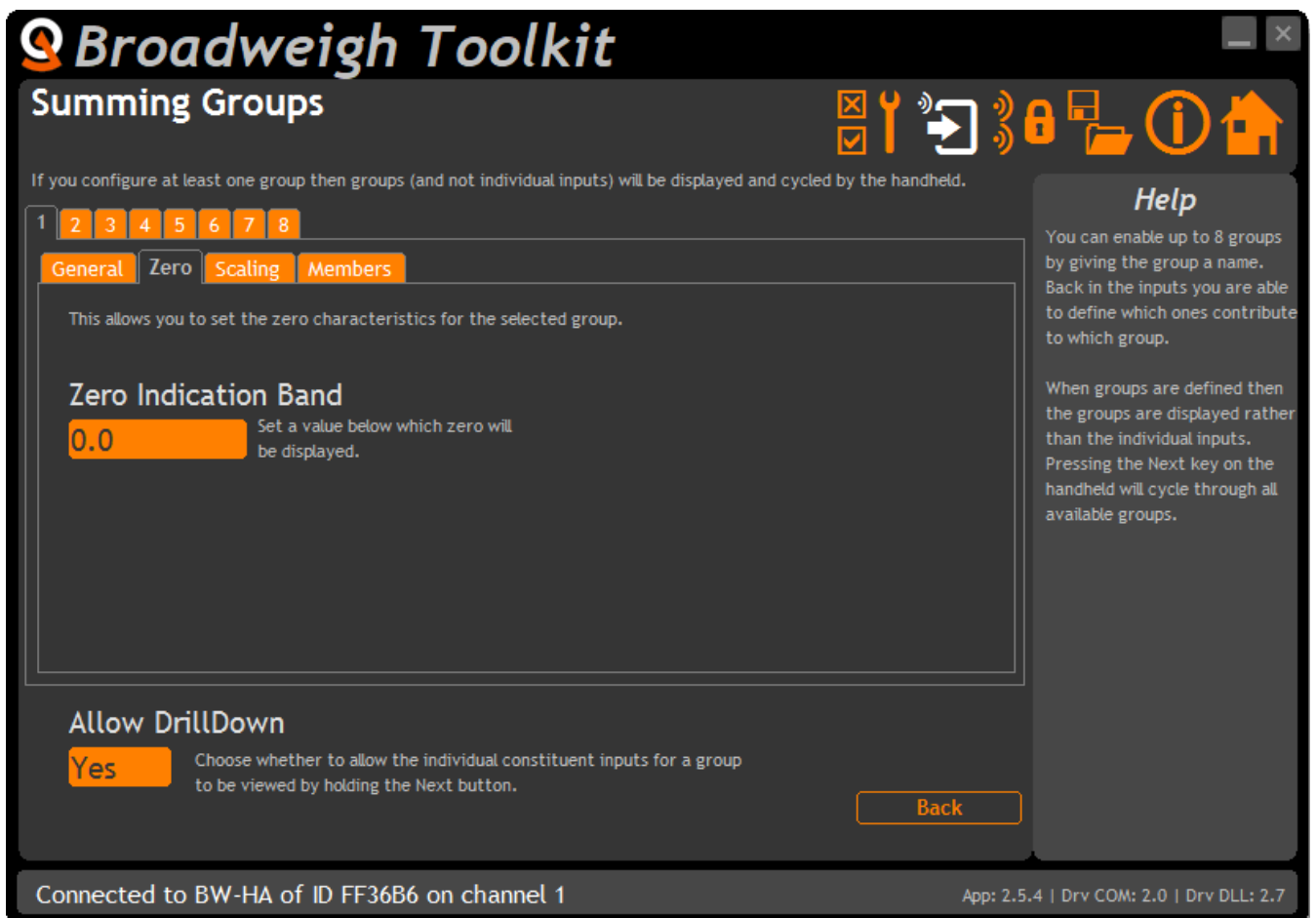

Here you can adjust the zero of the selected summing group.

Items you can change:

- | | |
|----------------------|--|
| Zero Indication Band | Using this setting you can mask tiny changes in input after you press the Tare button. Entering zero will disable this function. Entering a non-zero value will provide a band within which the display will always read zero. Once the reading exceeds this value the real weight will be displayed as no taring is taking place. |
| Allow Drilldown | When at least one Summing Group has been named the Next key will cycle through group totals rather than individual inputs. If you allow drilldown then holding the Next key for a long press will start to display the individual inputs that are members of the group. Each press of the Next key will show the next input in the group. After the last input has been shown the display will revert back to displaying the groups again. |
| Back Button | Click the 'Back' button to display the Transmitter Inputs pages again. |

Broadweigh Toolkit

Summing Groups

If you configure at least one group then groups (and not individual inputs) will be displayed and cycled by the handheld.

1 2 3 4 5 6 7 8

General Zero **Scaling** Members

You can rescale the value displayed from this group. This can be used to convert between different units for example. If you do not want to use scaling set GAIN to 1 and OFFSET to 0.

Gain 1.0 The original value from the group will be multiplied by this value.

Offset 0.0 The specified offset value will be added to the result of the gain multiplication to give the new final value for the group.

Allow DrillDown Yes Choose whether to allow the individual constituent inputs for a group to be viewed by holding the Next button.

Back

Help

You can enable up to 8 groups by giving the group a name. Back in the inputs you are able to define which ones contribute to which group.

When groups are defined then the groups are displayed rather than the individual inputs. Pressing the Next key on the handheld will cycle through all available groups.

Connected to BW-HA of ID FF36B6 on channel 1 App: 2.5.4 | Drv COM: 2.0 | Drv DLL: 2.7

Here you can configure the scaling for the selected Summing Group.

Use the Gain and Offset to manipulate the summing groups value. This can perform quite a few useful functions such as:

Zero a Sum – If the sum of the Transmitters have has a value that you want to remove but do not want to perform a system zero at each of the transmitters you can use the Offset to remove that value. Setting the Offset to 10 will remove 10 from the sum for example.

Convert Units – If the transmitters were calibrated in kg and you wish to display the sum in lbs you can set a Gain of 2.20462 and an Offset of 0.0

Change Polarity – If the sum value is negative but you want to display a positive value set the Gain to -1.0 and the Offset to 0.0



Actual Displayed Value = Transmitted Values Sum * Gain - Offset

Items you can change:

- | | |
|--------|--|
| Gain | This value will be multiplied by the transmitted sum value to provide the actual displayed value. The default is 1.0 |
| Offset | This offset will be applied to the transmitted sum value (After gain is applied) to provide the actual displayed value. The default is 0.0 |

- Allow Drilldown** When at least one Summing Group has been named the Next key will cycle through group totals rather than individual inputs.
If you allow drilldown then holding the Next key for a long press will start to display the individual inputs that are members of the group. Each press of the Next key will show the next input in the group. After the last input has been shown the display will revert back to displaying the groups again.
- Back Button** Click the 'Back' button to display the Transmitter Inputs pages again.

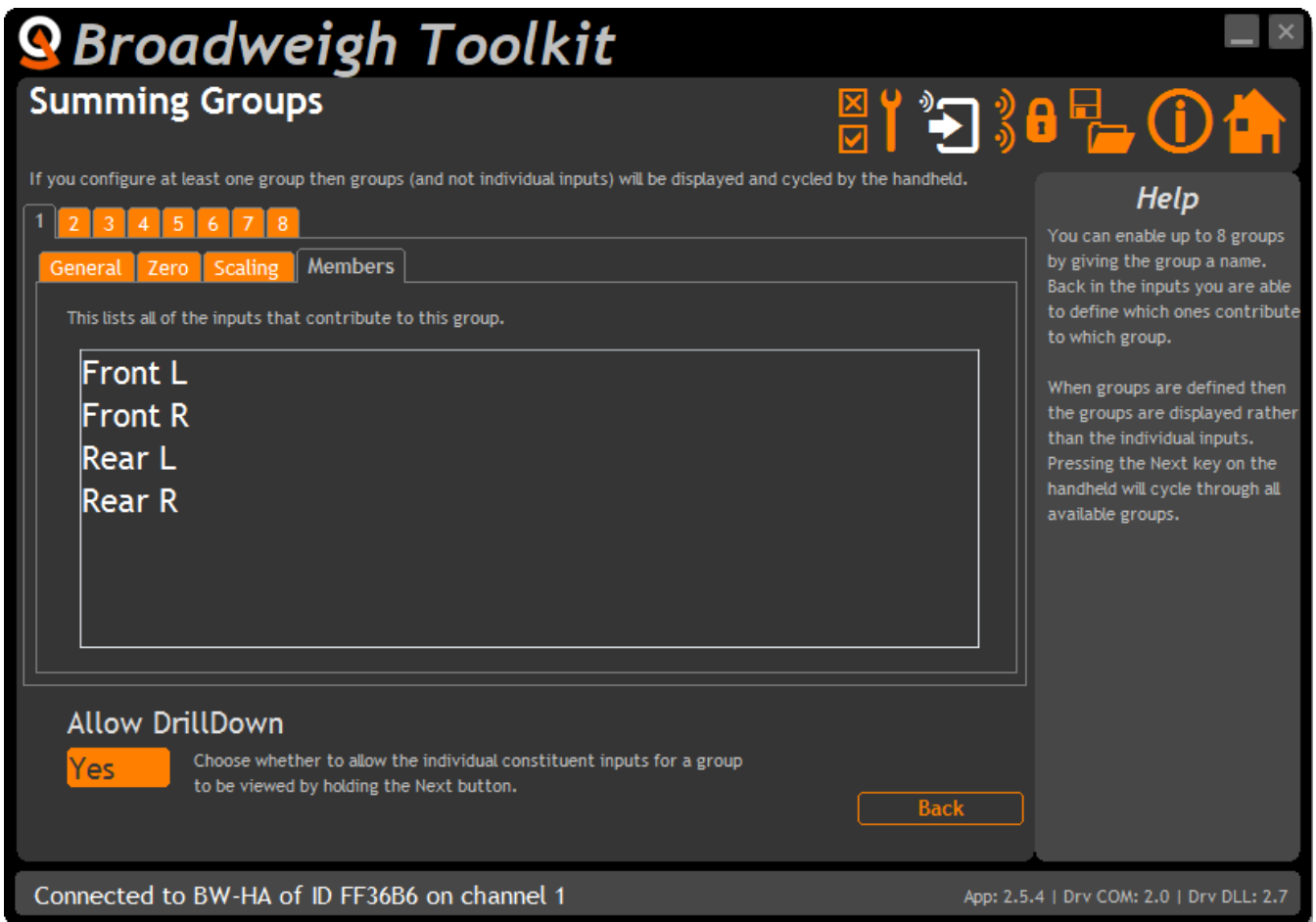

Here you can see a list of inputs that are members of the selected Summing Group and whose transmitted values are summed to create the value displayed by the group. The list will display the name of the input or the Data Tag if no name is assigned.

Items you can change:

Allow Drilldown When at least one Summing Group has been enabled, by entering a Name, the Next key will cycle through the Summing Group totals rather than individual inputs. If you allow drilldown then holding the Next key for a long press will start to display the individual inputs that are members of the group. Each press of the Next key will show the next input in the group. After the last input has been shown the display will revert back to displaying the groups again.

Back Button Click the 'Back' button to display the Transmitter Inputs pages again.

Example Configuration Scenarios

Examples Using No Defined Transmitter List (Roaming Mode)

The following examples show scenarios where it would be impractical to define each available transmitter because either there are more than 24 transmitters or the transmitters available may change and re-configuration of the handheld is undesirable.

So for these examples the handheld has no Transmitter Inputs defined and therefore operates in 'Roaming' mode where it can display the value from any transmitter on the same radio channel and Group Key. The Sleep Delays of the shackles are set to 30 seconds as in this mode the handheld will wake the shackles but not send them to sleep.

Festival Site

A festival site has several stages all with less than 24 Broadweigh shackles all set to the same radio channel and group key. The chief rigger for the site can go between stages and pick up the nearest 24 shackles with one handheld. They can then move on to the next stage and monitor the loads there.

Tent Guy Wires

A large tent has shackles attached to the guy wires. Each shackle has its LED visible so when the handheld is displaying the value from a particular guy wire the operator has visual feedback of the selected wire. Because the operator needs to physically inspect each wire he needs to approach each one individually. By using a Set Size of 1 on the handheld, each press of the Next key will effectively select the shackle with the highest transmission signal level so as the operator approaches each guy wire and presses the Next key he would see the LED light on the nearest wire's shackle and therefore know he was looking at the reading for the correct wire without having to pay attention to the displayed Data Tag.

Example of Defined Transmitter List

Single Transmitter

The Data Tag of a Wind Speed Sensor is defined as the only Input. Now when the handheld is turned on the Wind Speed Sensor is woken up and the operator can read the current wind speed. When the handheld is turned off the Wind Speed Sensor is also sent to sleep to conserve the battery.

Multiple Transmitters

A PA company has four speaker clusters suspended from Broadweigh shackles to be monitored from one handset. The Data Tags from each shackle are defined in the Input List. The Inputs are named as PA L, PA R, Delay 1 and Delay 2 so that as the operator clicks the Next key he can see which cluster he is monitoring. A long press on the Next key shows the name of the currently viewed shackle without moving to the next one.

Example of Summing Groups

Alternative Units

A truss is suspended from two Broadweigh shackles and the operator wants to view the total load in both tonnes and lbs. The shackles are calibrated in lbs.

First, each shackle is added to the defined list of Inputs by entering its Data Tag.

Next, a Summing Group is defined with the name **lbs** and both inputs are assigned as members of this group.

Another Summing Group is defined with the name **tonnes** and both inputs are assigned as members of this group as well.

To achieve the unit conversion the scaling of the tonnes group is configured to convert lbs to tonnes so the **Gain** is set to **0.000453592**

Now, when the handheld is turned on, both shackles are woken and the sum in **lbs** is displayed. By clicking the Next key the operator can switch between displaying **lbs** and **tonnes**. A long press of the Next key will display the name of the group and hence the units being displayed.

Grouping Sums

A suspended box truss has a shackle fitted to each corner and the handheld is used to monitor various aspects of its loading.



The operator wants to know total weight and also how the box truss is balanced so the handheld is going to display Summing Groups

First we would assign the four shackles to the inputs by defining their Data Tags.

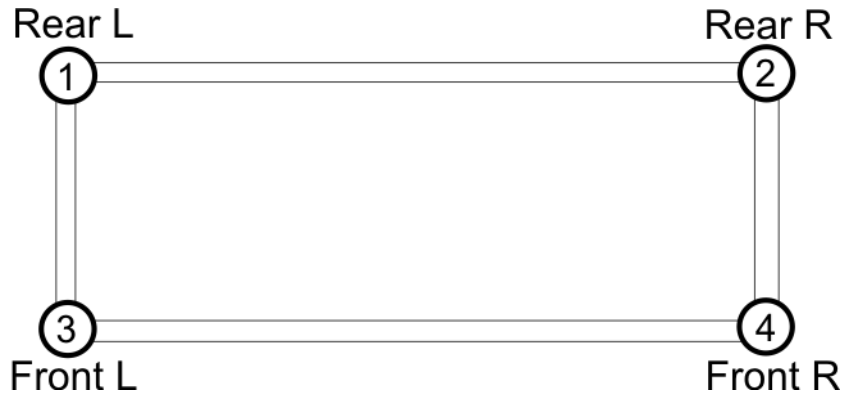

The inputs are named as follows:

- 1 Rear L
- 2 Rear R
- 3 Front L
- 4 Front R

If we did not assign Summing Groups at this point then the handheld would just cycle around these four inputs as the Next key is pressed.

However, we would like to know the total weight and also see how the box truss is balanced left to right and also front to rear so we will add five Summing Groups as follows.

- Assign the name **Total** to Summing Group 1
- Assign the name **Rear** to Summing Group 2
- Assign the name **Front** to Summing Group 3
- Assign the name **Left** to Summing Group 4
- Assign the name **Right** to Summing Group 5

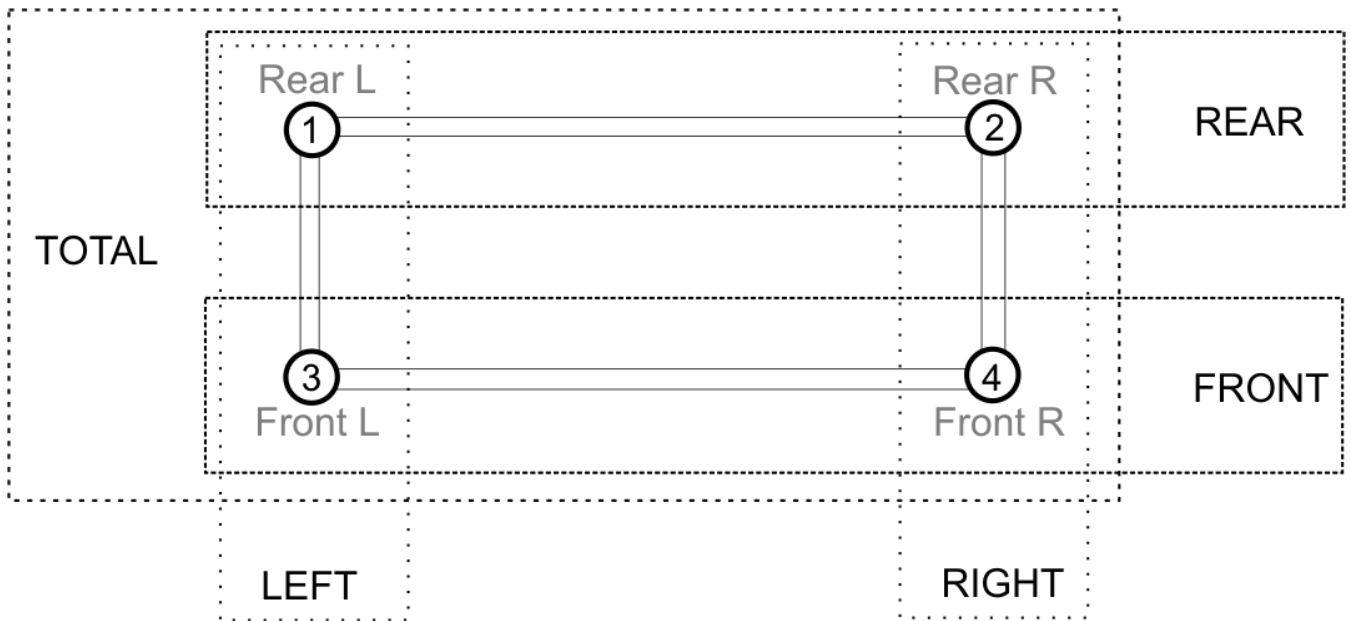

Now we need to assign the appropriate input to membership of the groups. So by going back to look at each defined input we simply assign the following inputs to each group.

- Input 1 **Rear L** is assigned to group **Total, Rear** and **Left**
- Input 2 **Rear R** is assigned to group **Total, Rear** and **Right**
- Input 3 **Front L** is assigned to group **Total, Front** and **Left**
- Input 4 **Front R** is assigned to group **Total, Front** and **Right**

Now when the handheld is turned on it will be displaying group **Total** and the operator will see the total weight of the box truss. Pressing the Next key will then display **Rear, Front, Left** then **Right** totals before cycling back to displaying the **Total**. If we allowed Drilling Down then a long press while viewing any of the group totals will allow the constituent inputs to be viewed one after another before returning to the groups again.

Enclosure & Mounting

See [Appendix A – A Style](#) section for more information.

Antennas

These modules have the antenna already fitted inside the enclosure so there are no specific mounting requirements.

Specification

Electrical	Min	Typical	Max	Units
Power Supply voltage	2.3	3.0	3.6	Vdc

Power Supply	Min	Typical	Max	Units
Active		40	55	mA
Low power mode		5	20	µA
Estimated Battery life using Energizer L91 AA batteries:				
Standby mode (Powered off)		>5		Years
Continuous operation		54		Hours

Environmental	Min	Typical	Max	Units
IP rating		IP67		
Operating Temperature Range	-10		+50	C
Storage Temperature	-40		+85	C
Humidity	0		95	%RH

Physical				
Hand Held Dimensions	90 mm x 152 mm x 34 mm			

Radio Range

To determine radio range please refer to [Appendix B – Antenna Range](#)

BW-RM1

Overview

The BW-RM1 offers dual power relays capable of mains power switching. These relays can be configured as high, low or window alarms and can be associated with a group of up to 8 Broadweigh transmitter modules per relay. Relays can operate when the sum of the assigned transmitter modules reach a set point or when any of the modules reach the set point. There is also a mode where the difference between the lowest and highest value is compared to the set point. This is useful for applications where you are looking for a group of weights to be within a certain band. i.e. hanging truss.

Relays can be latched and a digital input or external command can be used to reset them.

An alarm/error signal relay is operated if communication is lost or other selectable errors occur and this alarm resets once the source of the alarm or error is removed.

This module is supplied in an IP67 sealed ABS case.

The state of the power relays during an error can be selected.

Order Codes

BW-RM1



Relay module housed in weatherproof enclosure.

Connections

Power

You will need to connect power to the BW-RM1 for it to operate. Only power is required to enable configuration using a base station and the appropriate toolkit software.

Power is connected to the two part two way screw terminal connector as shown in the diagram below.

Connections & Indicators

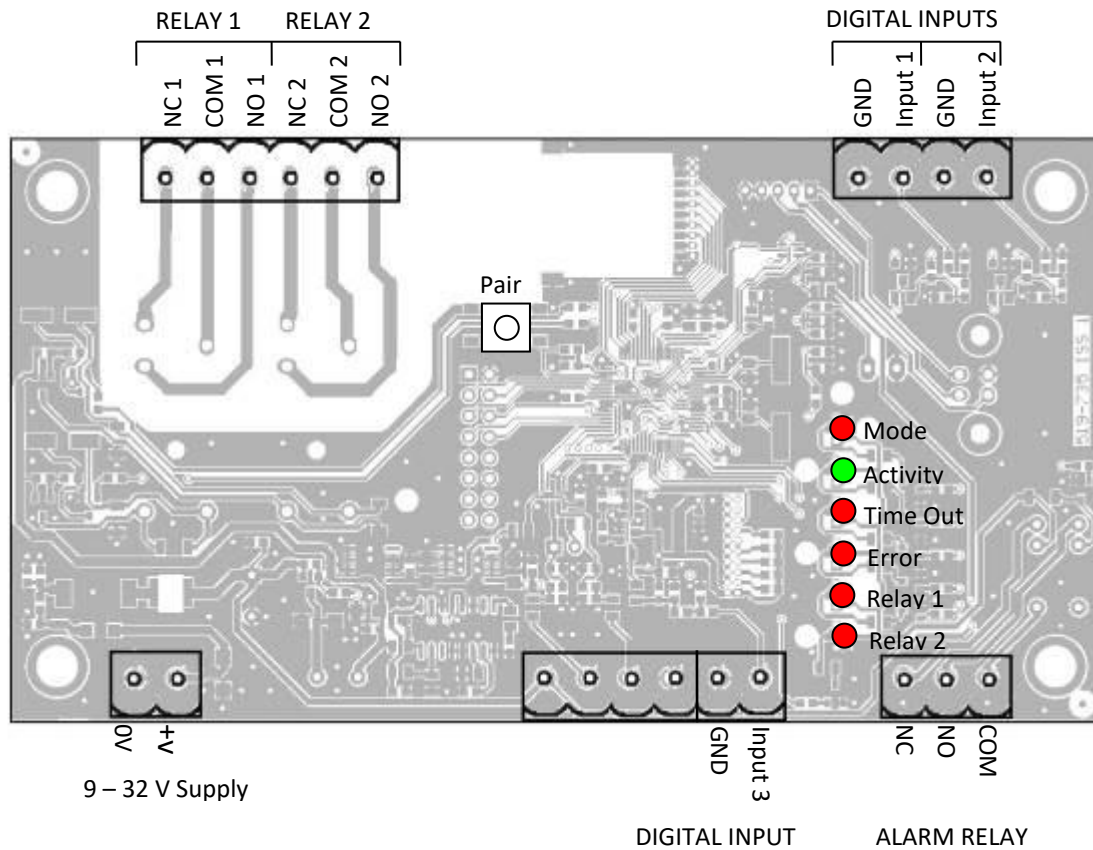

LEDs

Mode	Flashes 2 x per second when operational
Activity	Flashes when Broadweigh data packets are received
Time Out	No Broadweigh data present for longer than user defined period
Error	One or more contributing modules are reporting an error
Relay 1	Relay 1 Energised (Connection between COM and NO)
Relay 2	Relay 2 Energised (Connection between COM and NO)

Inputs

Digital Input 1	Can either reset a latched relay 1 or transmit a Data Provider Packet of a specified Data Tag
Digital Input 2	Can either reset a latched relay 2 or transmit a Data Provider Packet of a specified Data Tag
Digital Input 3	Resets both latched relays

Operation

The Broadweigh RM1 can accept 8 Broadweigh data inputs for each of the two relays, the total of the inputs compared to the set point and mode of the relay channel affects whether the relay is energised or not. In addition when considering the use of relays attention should be paid as to what state the system will be in when the power is off and the relays are de-energised. The diagram below outlines how wiring and normal and inverse modes influence the state of relays. (COM = Common, NO = Normally Open, NC = Normally Closed)

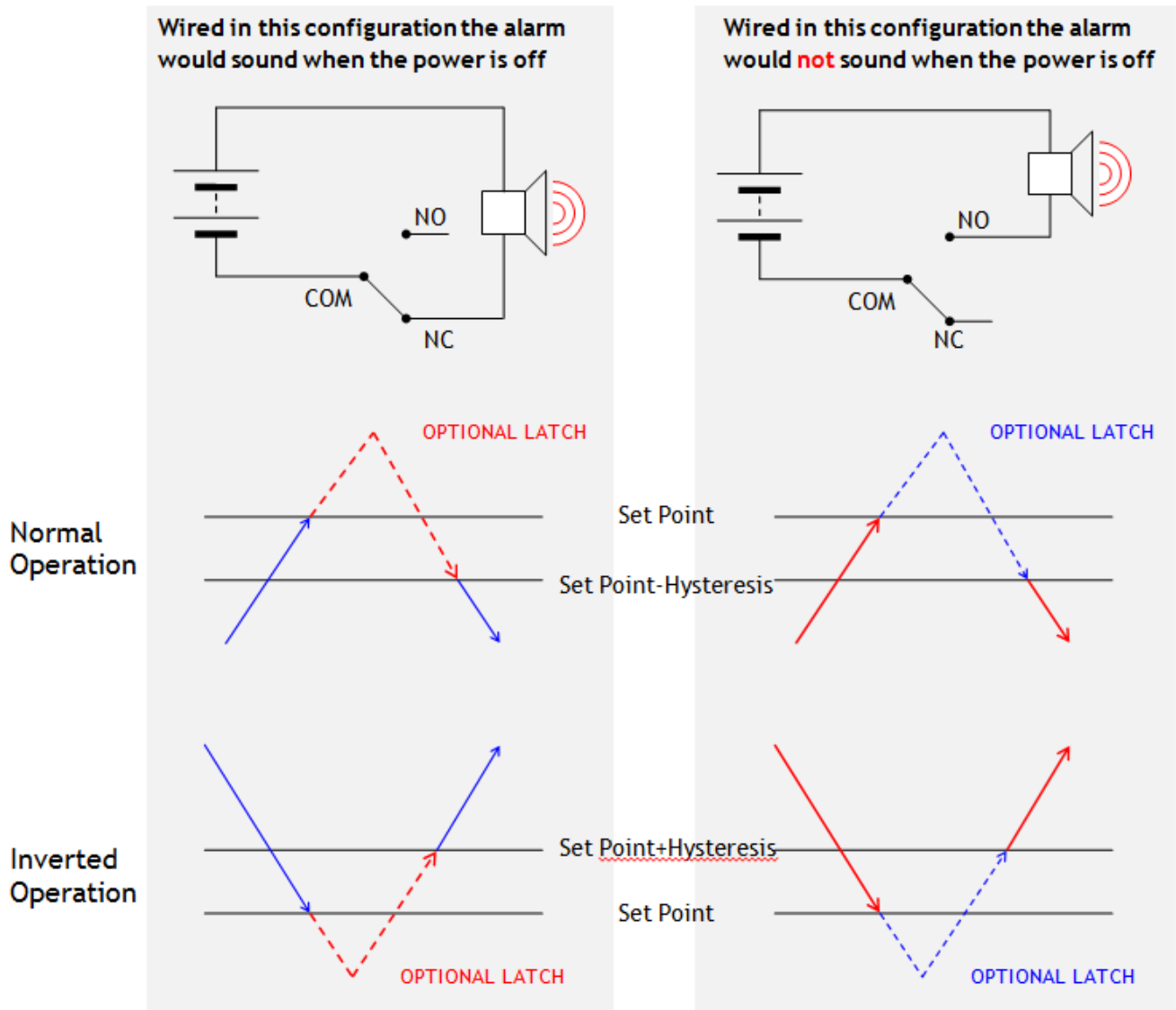

KEY:

↗	Increasing Value	_____	Relay Energised	_____	Alarm Activated
↘	Decreasing Value	-----	Relay Unenergised	_____	Alarm Deactivated

Relays can change state due to the following events:

- Arrival of Broadweigh data from user defined Broadweigh module that causes the relay output to trigger.
- Triggering of digital input 1 or 2 (switch input) which if configured reset latched relays
- Arrival of data from a specified data tag can reset latched relays.
- A change in error state of a module specified in a relays list of inputs

The BW-RM1 also features a third Alarm relay. The Alarm relay is energised from start up, (alarm connection made between COM and NC). The relay de-energises if an error is detected. An error is classed as a timeout and optionally can include Integrity error or low Battery. The Alarm Relay will return to normal (energised) once the source of the error is removed.

Configuration

The Broadweigh Toolkit provides a means of simple configuration of the module along with useful tools to aid integration.

Launch the Broadweigh Toolkit software application and pair to this module to enable the connection to the Toolkit to allow configuration to take place. [See Common Toolkit Pages - Home](#)

Input Settings

Broadweigh Toolkit

Input Settings

Here you can define a set of up to 8 data tags that will supply data for each relay. Click the 'P' buttons to pair to a module or enter the data tag manually. Click the 'X' button to zero the data tag entry and ignore that item.

Relay 1
'Sum' Mode
The values from the Data Tag set will be summed and the total used to compare to the setpoint.

Data Tag	Data Tag
1 0000 P X	5 0000 P X
2 0000 P X	6 0000 P X
3 0000 P X	7 0000 P X
4 0000 P X	8 0000 P X

Zero Offset
Enter an offset which will be subtracted from the summed inputs above before being compared to the setpoints.

0.0

Input Total
These displays show the input value that is used to compare against the setpoints.

0.0

Relay 2
'Sum' Mode
The values from the Data Tag set will be summed and the total used to compare to the setpoint.

Data Tag	Data Tag
1 0000 P X	5 0000 P X
2 0000 P X	6 0000 P X
3 0000 P X	7 0000 P X
4 0000 P X	8 0000 P X

0.0

Help
Each relay can operate on the sum of up to eight data providers. This page is where you define those inputs by specifying the Data Tags of the modules providing the data. An offset may be applied to zero the input sums to make calculating setpoints easier.

Connected to BW-RM1 of ID FF7F15 on channel 1

App: 2.0.0 | Drv COM: 1.7 | Drv DLL: 2.6

Here you can set the Data Tags of the data used as the inputs.

The description below the 'Relay1' and 'Relay2' captions indicate the way in which the values from the Data Tags will be used to compare against the setpoint to determine whether the relay will activate.

See the **Relay Operation Settings** section for details.

Items you can change:

- | | |
|------------------------|--|
| Relay 1 Data Tag [1-8] | Enter up to eight Data Tags the data from which will be used to determine the value compared to the set point to control relay 1. |
| Relay 2 Data Tag [1-8] | Enter up to eight Data Tags the data from which will be used to determine the value compared to the set point to control relay 2. |
| Zero Offset [1-2] | This value will be subtracted from the total of the summed data from the data tags for Relay 1 and Relay 2. Only used in Sum mode. |

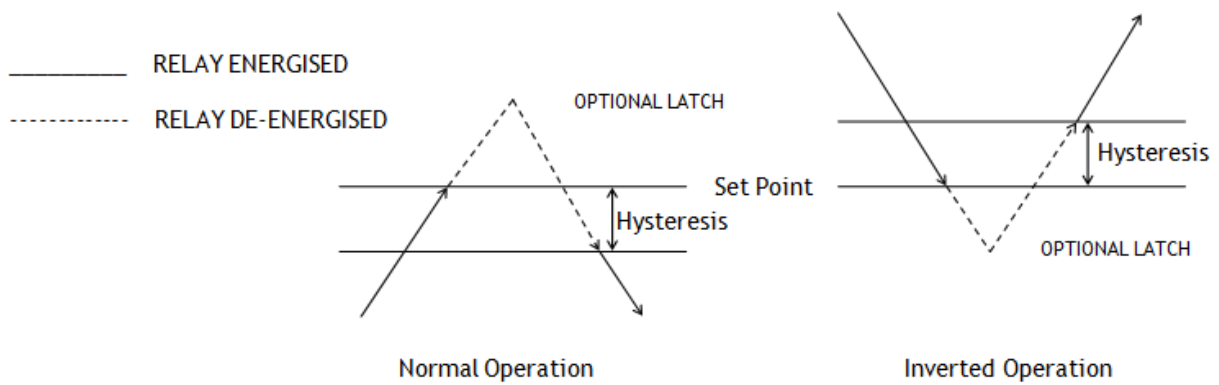

Relay de-energises when reaching the set point.

Relay Settings Advanced

Here you can change various settings that influence the operation of the individual relays.

Items you can change:

Relay Reset Data Tag [1-2] Enter a Data Tag that on receipt will reset the latched relay. Enter zero to disable this feature. Only useful if custom software or modules are utilised.

Waker Duration Enter zero to disable this feature.
Enter a time in milliseconds for this module to attempt to wake transmitter modules when first powered up. The default is 12000 milliseconds (12 seconds). All modules on the same radio channel and sharing the same Group key will be woken when the relay module powers up when this function is enabled.

Transmitter modules will be kept awake while this module has power applied. The transmitter modules should have a Sleep Delay set so that after the relay module has been powered down the transmitter modules then return to sleep.

Alarm Settings

Broadweigh Toolkit

Alarm Settings

	Relay 1	Relay 2	
Timeout (s)	001	001	Enter the timeout in seconds for each relay. If no data arrives for this period from one of the contributing inputs the alarm state will be active.
Error Mode	0-Timeout		Determine what constitutes error mode.
Error Action	0-Hold Last State	0-Hold Last State	Here you can define what happens to the relays when an error state occurs.
Digital Input Action	0000	0000	If you enter zero here the digital inputs will reset the latched relays. If you enter a Data Tag the input sum will be transmitted as a Data Provider packet on input. NOTE: Digital input 3 always resets BOTH latched relays.

Help
Here you can define the settings relating to alarms, errors and the functionality of the digital inputs.

Connected to BW-RM1 of ID FF7F15 on channel 1 App: 2.0.0 | Drv COM: 1.7 | Drv DLL: 2.6

This page defines how the individual relays will react to time outs and errors present from any defined Broadweigh module, as well as how Digital inputs 1 and 2 are used.

Items you can change:

- | | |
|--------------|--|
| Timeout | Enter a time in seconds that if exceeded the BW-RM1 will affect the relay state according to the error action, as well as set the alarm relay and light the time out LED |
| Error Mode | The error mode defines what causes the alarm relay and individual error action to be triggered. Errors can be defined as <ul style="list-style-type: none"> • Time out • Time out or Low Battery • Time out or Low Battery or Integrity Error |
| Error Action | For each relay the action upon error detection can be defined as ; <ul style="list-style-type: none"> • Hold Last State • De-Energise Relay • Energise Relay |

Digital Input 1

Digital input 1 can be used to either

- Reset Relay 1 from its latched state
- Transmit a data provider with user defined data tag containing the total of the inputs of Relay 1

Digital Input 2

Digital input 2 can be used to either

- Reset Relay 2 from its latched state
- Transmit a data provider with user defined data tag containing the total of the inputs of Relay 2

Enclosure & Mounting

This module is fitted inside our large, ACM ABS enclosure. Please see [Appendix A – B Style](#) for more information and optional mounting.

Antennas

These modules have the antenna already fitted inside the enclosure so there are no specific mounting requirements.

Specification

	Min	Typical	Max	Units
PSU	9	-	32	Vdc
Operational Current All Relays Active		155*		mA
Operational Temperature Range	-10		60	°C
Storage Temperature Range	-40		70	°C
Power Relays		240 V 5 A		
Alarm Relay		1 A 24 Vdc	1 A 120 Vac	

* At 12 V nominal Supply

Radio Range

For details of radio range please refer to [Appendix B – Radio Range](#)

BW-WM1

Overview

The BW-WM1 offers three 'traffic light' indicators that can be used to warn operators of user definable statuses in the Broadweigh system.

The green indicator shows when data is being received from up to 16 configured transmitter modules (or a single combined status of up to 100 transmitters from the Log100 software) while an amber and red indicator can be configured to activate under user defined conditions with each having up to 8 individual transmitters assigned to each.

The criteria used to activate indicators is under full user control and can be configured for when the sum of the assigned transmitter modules reaches a set point or when any of the modules reach the set point. There is also a mode where the difference between the lowest and highest value is compared to the set point. This is useful for applications where you are looking for a group of weights to be within a certain band. i.e. hanging truss.

Indicators can be latched and a digital input or external command can be used to reset them.

The green indicator will deactivate if communication is lost or other selectable errors occur and this will activate again once the source of the alarm or error is removed.

This module is supplied in an IP67 sealed ABS case.

The state of the indicators during an error can be selected.

There is also a simple **Log100 Mode** offered for when the module is used with a suitable plugin for the Log100 software. In this mode there is only one thing to configure and the green indicator shows when data is being correctly received from both Log100 and all transmitters configured in Log100. i.e. the green indicator will deactivate if data stops arriving from Log100 or any of the transmitters configured in Log100 stop transmitting.

The amber indicator activates when any Log100 display channel reaches the warning level and the red indicator activates when any display channel is under or over range.

Order Codes

BW-WM1



Warning module housed in weatherproof enclosure.

Connections

Power

You will need to connect power to the BW-WM1 for it to operate. Only power is required to enable configuration using a base station and the appropriate toolkit software.

Power is connected to the two part two way screw terminal connector as shown in the diagram below.

Connections & Indicators

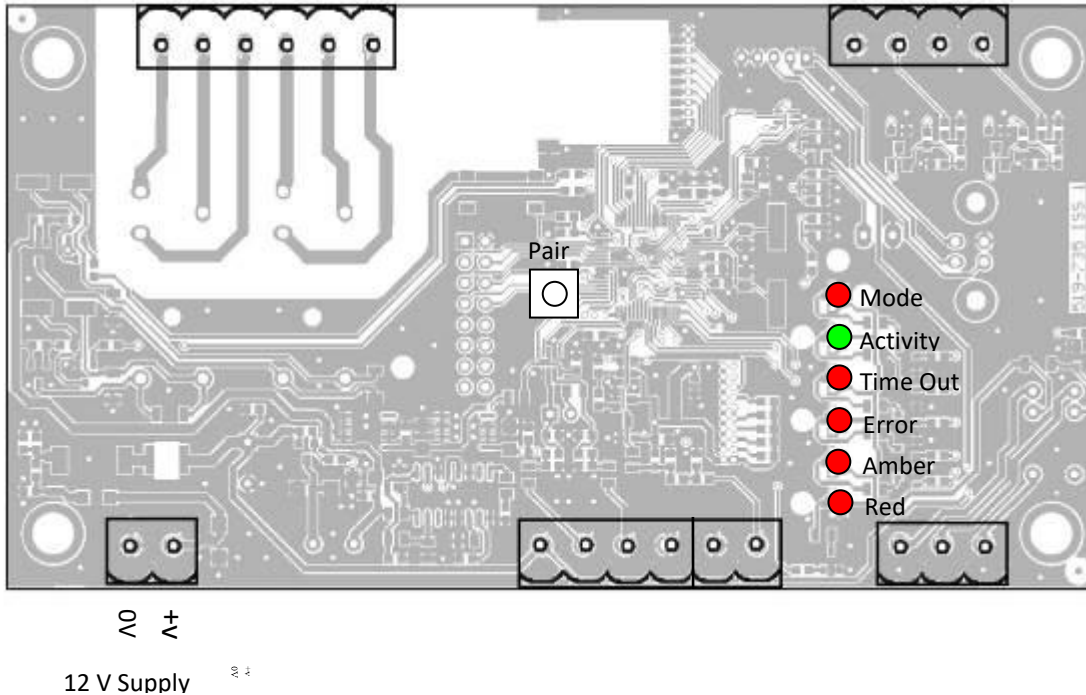

LEDs

Mode	Flashes 2 x per second when operational
Activity	Flashes when Broadweigh data packets are received
Time Out	No Broadweigh data present for longer than user defined period
Error	One or more contributing modules are reporting an error
Amber	Indicator Amber Active
Red	Indicator Red Active

Inputs

(Not used in Log100 Mode)

Digital Input 1	Can either reset a latched indicator 1 or transmit a Data Provider Packet of a specified Data Tag
Digital Input 2	Can either reset a latched indicator 2 or transmit a Data Provider Packet of a specified Data Tag
Digital Input 3	Resets both latched indicators

Operation

(In Advanced Mode only)

The Broadweigh WM1 can accept 8 Broadweigh data inputs for each of the two indicators, the total of the inputs compared to the set point and mode of the indicator channel affects whether the indicator is activated or not. In addition there is detailed control over hysteresis, latching and inverted operation which could be useful under some circumstances.

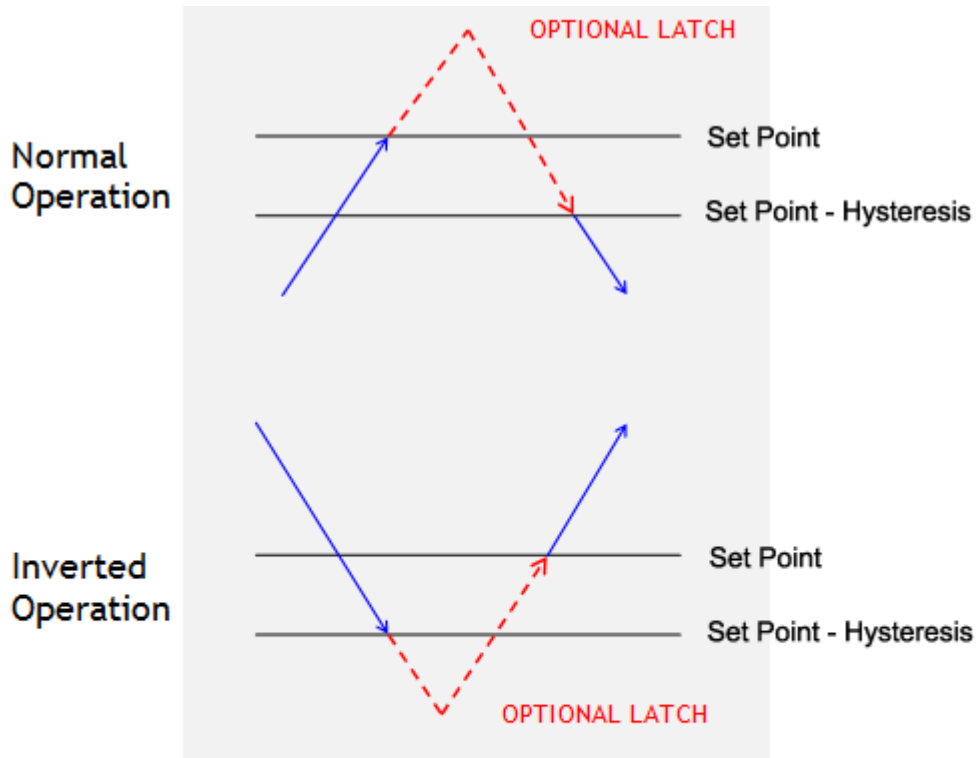

KEY:

- ↗ Increasing Value
- ↘ Decreasing Value
- Indicator Active
- Indicator InActive

Alarm

The BW-WM1 also features a third Alarm indicator which is an audible alarm which will sound when the red indicator is activated.

This can be deactivated by removing the module lid and disconnecting the brown wire from the floating two wire connector. The exposed end of the brown wire should be insulated with tape so it does not touch any other part of the circuit board.



The floating two wire connector showing the brown and grey wires fully inserted and locked.



To remove or refit a wire simply lift the orange arm to release the internal clamp.

Configuration

The Broadweigh Toolkit provides a means of simple configuration of the module along with useful tools to aid integration.

Launch the Broadweigh Toolkit software application and pair to this module to enable the connection to the Toolkit to allow configuration to take place. [See Common Toolkit Pages - Home](#)

Advanced Mode

This mode is used when you want full control over the configuration of the module. There is a simple Log100 Mode available for use with the Log100 software.

Input Settings

Broadweigh Toolkit
Input Settings

Here you can define a set of up to 8 data tags that will supply data for each indicator. Click the 'P' buttons to pair to a module or enter the data tag manually. Click the 'X' button to zero the data tag entry and ignore that item.

Warning Indicator
'Sum' Mode
The values from the Data Tag set will be summed and the total used to compare to the setpoint.

Data Tag	Data Tag
1 BBBB P X	5 0000 P X
2 0000 P X	6 0000 P X
3 0000 P X	7 0000 P X
4 0000 P X	8 0000 P X

Alarm Indicator
'Sum' Mode
The values from the Data Tag set will be summed and the total used to compare to the setpoint.

Data Tag	Data Tag
1 BBBB P X	5 0000 P X
2 0000 P X	6 0000 P X
3 0000 P X	7 0000 P X
4 0000 P X	8 0000 P X

Zero Offset
Enter an offset which will be subtracted from the summed inputs above before being compared to the setpoints.
0.0

Input Total
These displays show the input value that is used to compare against the setpoints.
0.0

Help
Each indicator can operate on the sum of up to eight data providers. This page is where you define those inputs by specifying the Data Tags of the modules providing the data. An offset may be applied to zero the input sums to make calculating setpoints easier.

Use With Log100

Connected to BW-WM1 of ID FDBB67 on channel 1
App: 02.09.21 | Drv COM: 2.0 | Drv DLL: 2.7

Here you can set the Data Tags of the data used as the inputs.

The description below the 'Indicator1' and 'Indicator2' captions indicate the way in which the values from the Data Tags will be used to compare against the setpoint to determine whether the indicator will activate.

See the **Indicator Operation Settings** section for details.

Items you can change:

- | | |
|----------------------------|--|
| Indicator 1 Data Tag [1-8] | Enter up to eight Data Tags the data from which will be used to determine the value compared to the set point to control indicator 1. |
| Indicator 2 Data Tag [1-8] | Enter up to eight Data Tags the data from which will be used to determine the value compared to the set point to control indicator 2. |
| Zero Offset [1-2] | This value will be subtracted from the total of the summed data from the data tags for Indicator 1 and Indicator 2. Only used in Sum mode. |

Operation and Hysteresis Settings

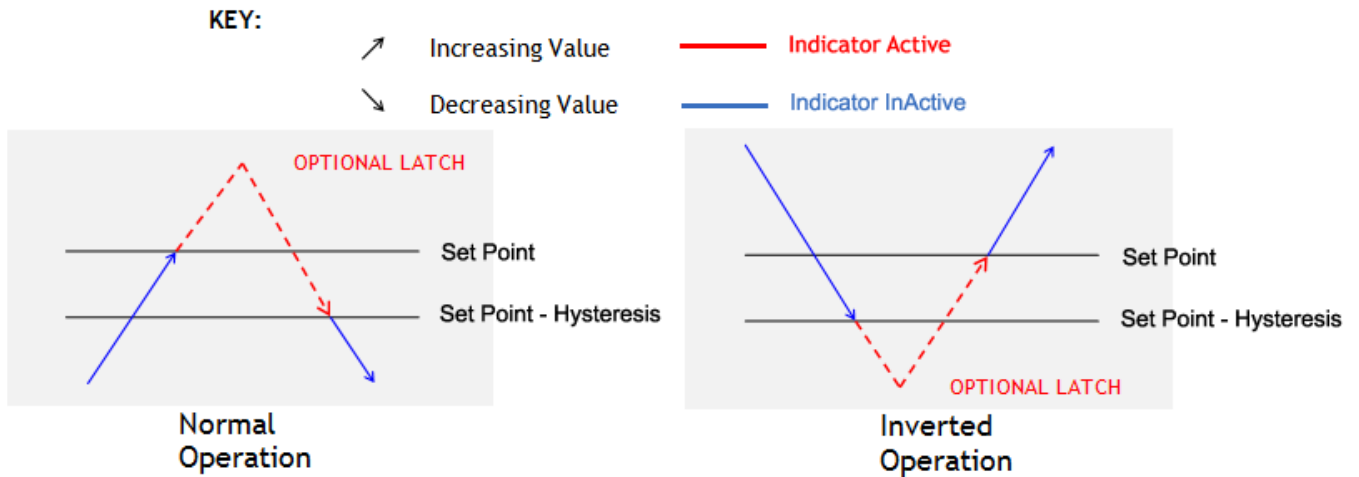

Indicator activates when reaching the set point.

Alarm Settings

This page defines how the individual indicators will react to time outs and errors present from any defined Broadweigh module, as well as how Digital inputs 1 and 2 are used.

Items you can change:

- Timeout Enter a time in seconds that if exceeded the BW-WM1 will affect the indicator state according to the error action, as well as set the alarm indicator and light the time out LED

Error Mode	<p>The error mode defines what causes the green indicator to be deactivated. Errors can be defined as</p> <ul style="list-style-type: none"> • Time out • Time out or Low Battery • Time out or Low Battery or Integrity Error
Error Action	<p>For orange and red indicators the action upon error detection can be defined as</p> <ul style="list-style-type: none"> • Hold Last State • Deactivate Indicator • Activate Indicator
Digital Input 1	<p>Digital input 1 can be used to either</p> <ul style="list-style-type: none"> • Reset orange indicator from its latched state • Transmit a data provider with user defined data tag containing the total of the inputs of Indicator 1
Digital Input 2	<p>Digital input 2 can be used to either</p> <ul style="list-style-type: none"> • Reset red Indicator from its latched state • Transmit a data provider with user defined data tag containing the total of the inputs of Indicator 2

Log100 Mode

This simplified mode is offered for when the module is used with a suitable plugin for the Log100 software. In this mode there is only one thing to configure and the green LED indicator activates when data is being correctly received from both Log100 and all transmitters configured in Log100. i.e. the green indicator will deactivate if data stops arriving from Log100 or any of the transmitters configured in Log100 stop transmitting.

The amber indicator activates when any Log100 display channel reaches the warning level and the red indicator activates when any display channel is under or over range.

Log100 Mode Settings



Here you can set the Data Tag to match the one configured in the Log100 software. This is the only setting you need to change in this very simple mode.

Items you can change:

Data Tag Enter a Data Tag to match the one configured in the Log100 plugin.

Additional Log100 Requirements

To use this simple mode you need a copy of the free **Log100** software which allows viewing logging and visualization of Broadweigh transmitter data.

You will also need the **DPAlerts** plugin software module to activate this feature at the Log100 side.

This can be downloaded from the Broadweigh web site.

Once the plugin has been installed use the **More...** menu in Log100 to select **Configure** under the **DPAlerts** heading.

Just click on the **Simple Mode For Broadweigh Warning Module** tab and make sure that the Data Tag matches the one set in the Toolkit as shown above.

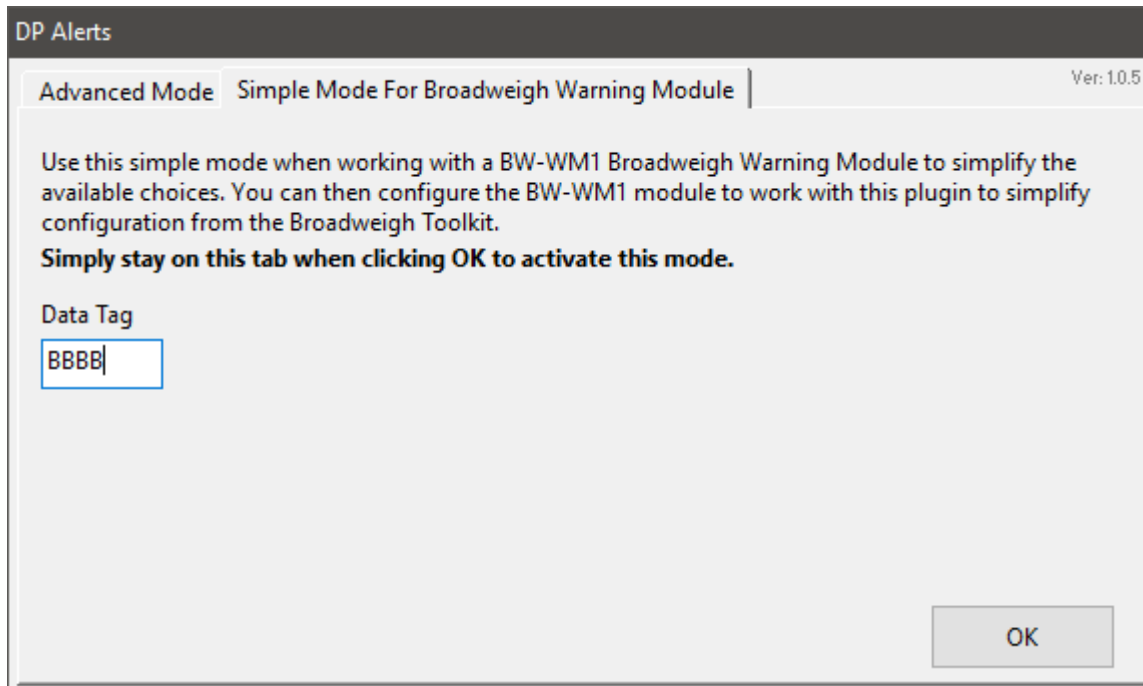

Enclosure & Mounting

This module is fitted inside our large, B Style ABS enclosure. Please see [Appendix A – B Style](#) for more information and optional mounting.

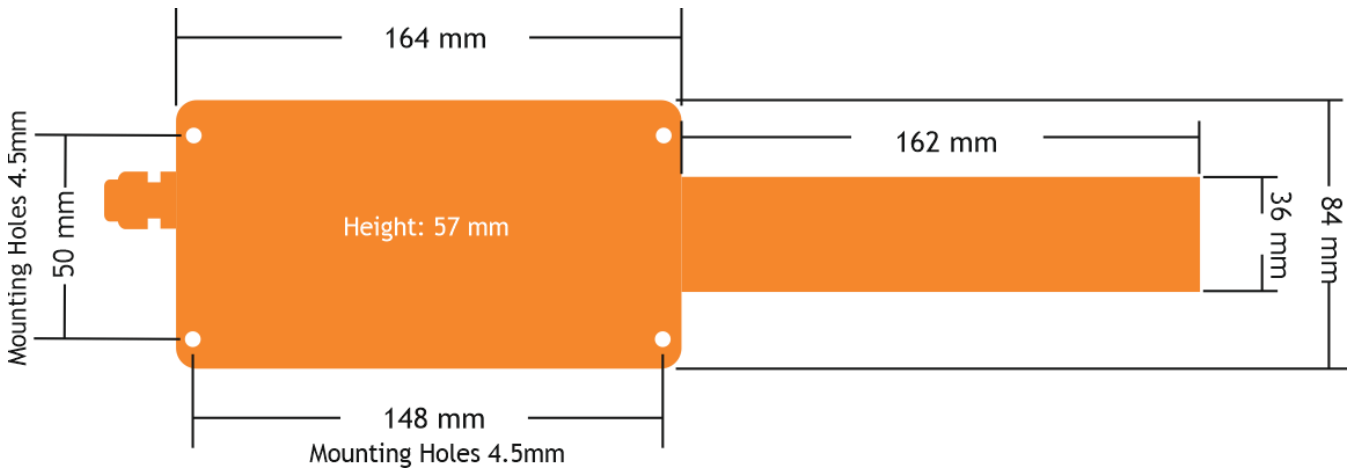

Antennas

These modules have the antenna already fitted inside the enclosure so there are no specific mounting requirements.

Specification

	Min	Typical	Max	Units
PSU		12		Vdc
Operational Current All Indicators Active		500		mA
Operational Temperature Range	-10		60	°C
Storage Temperature Range	-40		70	°C

Radio Range

For details of radio range please refer to [Appendix B – Radio Range](#)

Base Stations & Repeater Modules

Base stations are required for configuration of the Broadweigh modules using the Broadweigh Toolkit software. They are also used to supply data to PCs and PLCs.

Repeaters allow the effective radio range to be increased, allow better coverage and to divert around obstacles.

BW-BSue, BW-BSd, BW-BSi

Overview

Base stations are the interface between the Broadweigh radio system and a PC, PLC or other controller.

A base station would be required to configure Broadweigh modules from a PC using the Broadweigh Toolkit software and also required if you are to capture data from Broadweigh modules to a PC or PLC.

Order Codes

BW-BSue



Base station in weatherproof enclosure with USB connection. This is a more robust housing with more range than the BW-BSd.

BW-BSd



Base station mounted in a non-weatherproof USB dongle enclosure for direct connection to laptops and tablets.

BW-BSi



Base station mounted in large weatherproof enclosure. This variant has RS232, RS485 connections along with USB. This variant is ideal for permanent outdoor installations.

Addressing

Usually only a single base station is required in a broadweigh installation. If a shackle is outside the range of the base station a repeater may be deployed.

Some complex topologies may only be realised by using multiple base stations which may require changes to the **Address** switches. (Contact Mantracourt Electronics for advice regarding multiple base stations residing on a single serial bus)
The BW-BSi has interfaces for USB, RS232 and RS485 and is addressable. The USB only base stations (BW-BSue & BW-BSd) have a fixed address of 1 so only one can be connected to a PC at a time.

Connections

BW-BSue & BW-BSd

Connection to the base station will be either a captive USB cable (BW-BSue) or direct connection to a PC USB socket (BW-BSd).

To communicate with the base station the connected host device must use the USB HID Device Class and support USB 2.0 full speed interface (12Mbits).

The USB connection will also power the base station.



The noise generated due to the USB 3.0 data spectrum can have an impact on radio receivers whose antenna is placed close to a USB 3.0 connector. The noise is a broadband noise that cannot be filtered out, since it falls within the band of operation of the wireless device (2.4–2.5 GHz). The noise degrades the signal-to-noise ratio that the wireless receiver sees and limits its sensitivity. This then reduces the operating wireless range of the device. The operation of the Base Station Dongle (BW-BSd) devices may be adversely affected by some USB 3.0 ports depending on their location and whether they employ shielded receptacles. This may manifest itself in the inability to 'pair', reduced range or intermittent data reception.

Performance may be recovered by plugging the device into a different USB 3.0 port, plugging the device into a USB 2.0 port or using a short USB 2.0 extender cable (USB A male to USB A female).

BW-BSi

This diagram shows the available connections, switches and LEDs.

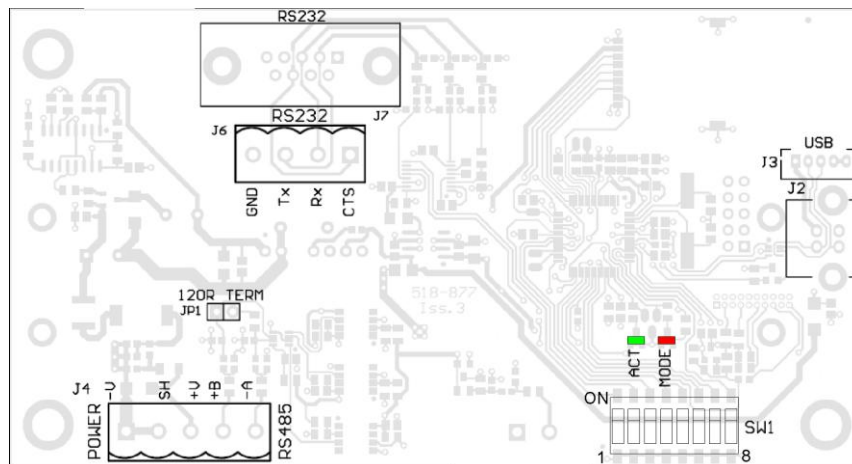

9Vdc – 32Vdc power on J4 –V and +V

The interface can be selected from the DIP switches **SW1** as can baud rates for serial interfaces and the Address of the base station.

SW1 Settings

Address

Switch positions 1 to 4 select the base station **Address**. This should normally be 1.

	1	2	3	4
Address	Off	Off	Off	Off

2	On	Off	Off	Off
3	Off	On	Off	Off
4	On	On	Off	Off
5	Off	Off	On	Off
6	On	Off	On	Off
7	Off	On	On	Off
8	On	On	On	Off
9	Off	Off	Off	On
10	On	Off	Off	On
11	Off	On	Off	On
12	On	On	Off	On
13	Off	Off	On	On
14	On	Off	On	On
15	Off	On	On	On
16	On	On	On	On

Serial/USB

Switch positions 5 to 7 set whether serial or USB is used. If USB is not selected then the chosen switch settings control the baud rate for the serial interface. Whether the serial interface is RS485 or RS232 is selected by switch position 8.

	5	6	7
Baud rate / USB			
USB	Off	Off	Off
9600	On	Off	Off
19200	Off	On	Off
38400	On	On	Off
57600	Off	Off	On
115200	On	Off	On
230400	Off	On	On
460800	On	On	On



A baud rate of 9600 (and in some cases 19200) is not suitable for 2 way communication with remote modules as it is too slow and causes timeouts. This baud rate has been included to enable the base station to be connected to a 9600 baud device to allow low rate Data Provider packets to be received.

At any rate below 230400 it may be possible to lose packets at high data rates as the serial connection cannot keep pace with the radio transmissions.

If USB is not selected as the interface (Switch positions 5 to 7) then this switch position selects whether the serial interface is RS232 or RS485.

	8
232/485	
RS232	Off
RS485	On

Power

USB base stations will be powered by the USB bus. If RS232 or RS485 are selected then external power will need to be connected to J4 on the -V and +V pins. 9Vdc to 32Vdc supply.

LED Indication

Two LEDs indicate Power/Mode and Activity.

The red LED indicates mode and should flash at a 2Hz rate. If any errors are detected with the radio then the LED will remain lit.

The green LED flashes once for each packet received or transmitted via radio, USB or serial.

RS232

The RS232 interface uses TX, RX and GND to connect to a PC, PLC etc. and uses standard RS232 voltage levels. The baud rate can be selected by setting the DIP switches stated above.

 The base station will require power cycling to utilise a baud rate change.

Example connection to a PC 9 way D serial connector.

PC 9 Way D Plug Pin	Signal Direction	Base Station Connection	
3 (TX)	->	RX	J6 RX or J7 Pin 3
2 (RX)	<-	TX	J6 TX or J7 Pin 2
5 (Gnd)		GND	J6 GND or J7 Pin 5
8 (CTS)	<-	CTS	J6 CTS or J7 Pin 8

RS485

The RS485 interface (This is a 2 wire 485 interface and will not work with 4 wire 485 buses) uses TX, RX and GND to connect to a PC, PLC etc. and uses standard RS485 voltage levels. JP1 header link should be fitted if this module is the last one on the RS485 bus. In most cases the JP1 link header should be fitted.

The baud rate can be selected by setting the DIP switches stated above.

 The base station will require power cycling to utilise a baud rate change.

Example connection

Depending on the RS485 interface or hardware the connections vary and are not standard therefore we can only show the connections to the base station. You must refer to the user manual regarding your RS485 connection to ascertain the correct connections.

PC / PLC Connection	Signal Direction	Base Station Connection	
Refer to RS485 Device User Manual		A	J4 -A
Refer to RS485 Device User Manual		B	J4 +B
Refer to RS485 Device User Manual		GND	J4 SH

Serial Limitations

- When using RS232 or RS485 you should use the fastest baud rate possible. At lower rates data can be lost because it can arrive from the radio faster than the base station can send it serially.
- At 9600 baud you will experience communications problems when configuring modules. This baud rate is too slow for anything other than monitoring data provider packets from modules and even then these should be at a low rate (around 20 per second). The slow baud rates are provided to get low rate data into older systems.
- RS485 is a bus master system and is not ideally suited to full communications with modules when multiple modules are providing data. This is fine for the normal operation of data transmitter but it is recommended that only the module to be configured is active during configuration.

USB

This module may also be connected via USB which will also power the base station.

A standard USB B cable can be connected to J2 but the lid cannot be fitted once this has been plugged in.

If a sealed module is required when using USB please contact Mantracourt Electronics and enquire about our optional socketed USB cable to pass through glands and attach to J3.

Configuration

The Broadweigh Toolkit provides a means of simple configuration and calibration of the transmitter module along with useful tools to aid integration.

Home

Broadweigh Toolkit

Home

Monitor or Log
You can view and log the data being transmitted from an acquisition module or view the spectrum analyser by clicking the icons above right. Pairing is NOT required to log data from your device.

Configure your device
To configure your module we need to temporarily pair to it. When we pair from the Toolkit we configure the base station radio settings to match the remote module.
To pair you must:

- Remove the power from your module.
- Initiate the pair by clicking the button below.
- Re-apply the power to the module.

When applying power be careful to do this cleanly because if the module is powered up with an intermittent connection it may reset during pairing and result in poor or no communications.

Pair

If the module cannot be paired because access to the power supply is either not possible or many modules share the same power supply. [Click Here](#) for manual connection.

Help
This Home page is where you begin your connection to your module.
You must be able to access its power supply so you can remove and reapply it.

The module you want to connect to must be the only module you re-apply power to.

When pairing to a module the base station radio settings are changed to match those of the remote module.

[To connect to the base station hold the Shift key while clicking the Pair button]

Connected to Base Station of ID FF8C80 on channel 1 App: 2.0.0 | Drv COM: 1.7 | Drv DLL: 2.6

You now have successful communications with the base station so you can now let the Toolkit know you want to configure the base station and **not** a remote module.

i To connect to and configure the connected base station, hold the **shift key** and click the **Pair** button.

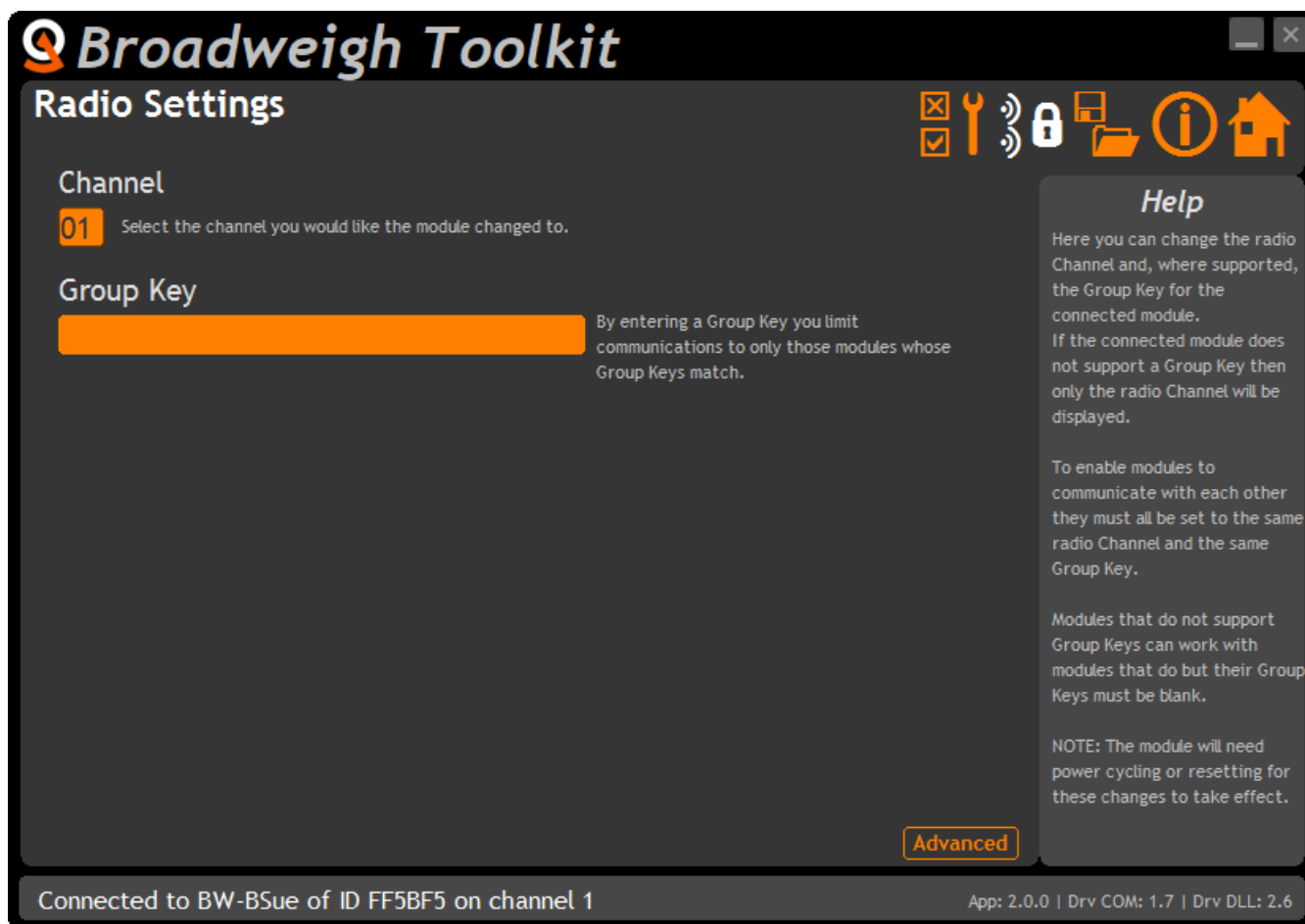

Here you can change the channel and group key for the base station.

Items you can change:

- | | |
|-----------|---|
| Channel | Select a channel between 1 and 15. The default is channel 1. You can use the Spectrum Analyser mode to determine a good clean channel to use. |
| Group Key | This section will only be visible if the version of the base station supports Group keys.
Only modules with identical group keys can communicate. You can isolate groups of modules on the same channel or just use the key to ensure the data cannot be read by somebody else.
To use modules that support Group Keys with older modules that do not then then the Group Keys must be blank. |
| Advanced | See Radio Settings Advanced (Not the next section) |



You should not normally need to change these settings.

Items you can change:

Waker Duration

When you send a wake command to a Broadweigh module via the base station the duration of this wake attempt is controlled by this setting. Enter the desired duration in milliseconds.

Enclosure & Mounting

BW-BSue

This module is fitted inside our medium enclosure. Please see [Appendix A – C Style](#) for more information.

BW-BSd

This module is fitted inside our small enclosure. Please see [Appendix A – H Style](#) for more information.

BW-BSi

This module is fitted inside our large enclosure. Please see [Appendix A – B Style](#) for more information and optional mounting.

Antennas

These modules have the antenna already fitted inside the enclosure so there are no specific mounting requirements.

Specification

BW-BSi

Parameter	Minimum	Typical	Maximum	Units	Notes
External Supply voltage Range	9	12	32	Vdc	
USB Supply Range	4.875	5	5.125	Vdc	As defined by USB 2.0 Specification
Average Operational Current	-	100	-	mA	At 12 V
Operating Temperature Range	-20	-	55	°C	
Storage Temperature Range	-40	-	85	°C	
Reverse polarity Protection		-	-32	Vdc	Maximum Supply
Environmental Protection			IP67		With cables exiting through glands
Cable Lengths:					
USB			5	m	
RS232 @ 115200 Baud			10	m	
RS485 @ 230400 Baud			300	m	

BW-BSd

Parameter	Minimum	Typical	Maximum	Units	Notes
USB Supply Range	4.875	5	5.125	Vdc	As defined by USB 2.0 Specification
USB Bus Powered Operational Current	-	100	-	mA	
Operating Temperature Range	-20	-	55	°C	
Storage Temperature Range	-40	-	85	°C	
Environmental Protection			IP50		

BW-BSue

Parameter	Minimum	Typical	Maximum	Units	Notes
USB Supply Range	4.875	5	5.125	Vdc	As defined by USB 2.0 Specification
USB Bus Powered Operational Current	-	100	-	mA	
Operating Temperature Range	-20	-	55	°C	
Storage Temperature Range	-40	-	85	°C	
Environmental Protection			IP67		Does not apply to USB connector at cable end

Radio Range

To determine radio range please refer to [Appendix B – Radio Range](#)

BW-AR

Overview

The BW-AR is an active repeater which will allow the Broadweigh range of modules to divert around obstacles or increase range or coverage.

The connectivity module provides a battery holder for a pair of alkaline 'D' cells and has regulator circuitry for an external power supply. The batteries can also be used to provide power in case of external supply failure.

The case is environmentally sealed to IP67.

The repeater will allow messages to be repeated once which could double the radio range under ideal conditions. Adding more repeaters will not increase range but can increase coverage.

Order Codes

BW-AR



Active Repeater module mounted in large weatherproof enclosure with battery holder for two D cell alkaline batteries. Also has ability to be powered from external supply voltage.

Connections

Power

Power can be supplied by fitting two 'D' cell alkaline 1.5 V batteries or the module can be supplied from an external 5 Vdc to 18 Vdc source. The module will switch to the external supply in preference providing a battery backup. In both cases the JP1 power jumper needs to be fitted to supply power to the module. When powered from the external DC source the LED will illuminate.

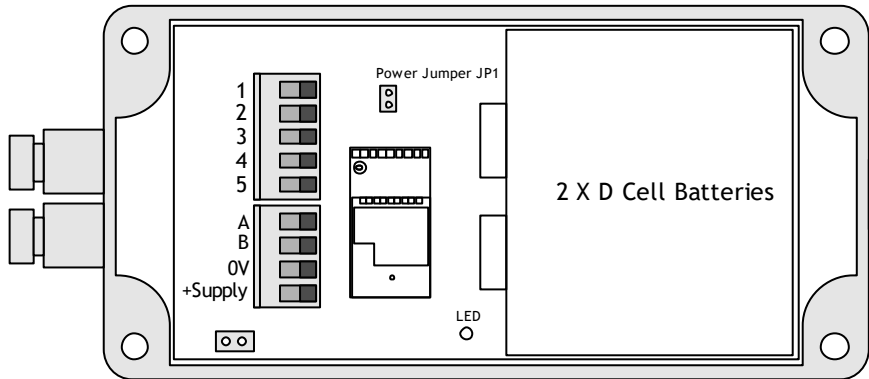

Power Options

The BW-AR can operate permanently powered from a 5-18 Vdc source or can operate from on-board batteries.

Permanently Powered





This is the simplest way to operate the repeater. With a permanent supply you do not need to worry about the repeater sleeping or waking. You can optionally choose whether the repeater always wakes sleeping modules and then you could utilise the powering up of the repeater to wake up those modules outside the normal radio range.

Battery Powered

In low power battery mode the repeater wakes from sleep when other modules are woken and will remain awake until it stops receiving Stay Awake messages. This will work transparently with most Broadweigh instrumentation. You just need to decide on the Sleep Delay for a battery powered repeater. This causes the repeater to enter sleep mode if it does not receive stay awake messages within the Sleep Delay time. Stay awake messages are transmitted by handhelds, analogue output modules and PC software etc. so that when those items are turned off or disabled all other Broadweigh modules will sleep when their Sleep Delay time elapses.

Getting Started

Use the Broadweigh Toolkit to ensure that the repeater radio channel matches the rest of the Broadweigh modules. You will then need to decide whether the repeater is battery powered or permanently externally powered and whether it should always wake other sleeping modules when it is powered up and awake.

KEY:  **BW Transmitter**
e.g. BW-S325  **BW Receiver**
e.g. base station or handheld  **BW Repeater**
BW-AR  **Obstacle**
Building, wall etc

Increase Range

With No
Repeater



With
Repeater



Span Obstacles

With No Repeater



With Repeater



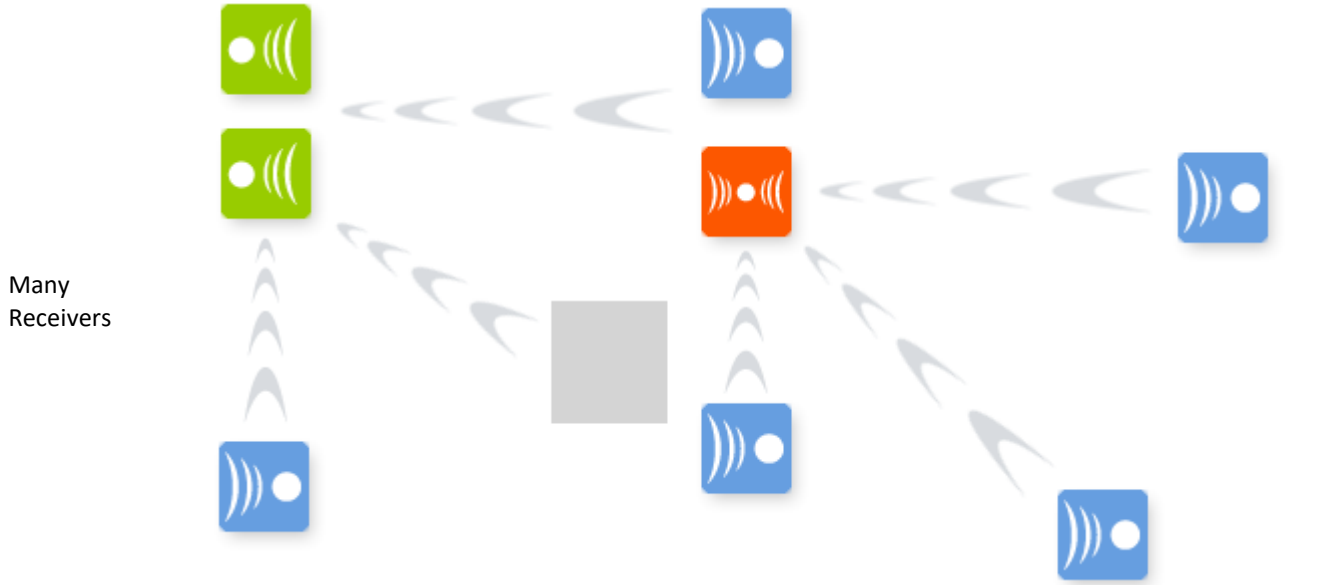

Considerations

- Each repeater can effectively double the amount of traffic transmitted. Be careful not to introduce too many repeaters that are within range of each other as there may be un-necessary duplication of radio traffic. Carefully plan the layout of radio modules to minimise this.
Using the Data Provider monitor in the Broadweigh Toolkit can show the amount of traffic. The Broadweigh Toolkit on a laptop or netbook is ideal for checking installations as it is mobile so traffic can be monitored at different points in the installation.
- A repeater will not repeat a packet that has already been repeated. Hence there is only one extra 'hop' introduced and a maximum doubling of the radio range.
- When waking remote modules separated by a repeater and that repeater is asleep it may take twice as long to wake a module as when no repeater is involved.
- If the repeater is to be battery powered use the same Sleep Delay as is suitable for the transmitter modules in the system.
- You cannot pair to a module through a repeater. Using the Broadweigh Toolkit it **may** be possible to configure module through a repeater by [soft pairing](#). The results will vary depending on the number of repeaters and amount of radio traffic. In some cases it may be necessary to power down repeaters when configuring modules.
- Most receiver modules and software issue a broadcast wake when turned on or activated and this will also wake a sleeping repeater which will then proceed to wake those modules within its range..

Configuration

The Broadweigh Toolkit provides a means of simple configuration and calibration of the transmitter module along with useful tools to aid integration.

Launch the Broadweigh Toolkit software application and pair to this module to enable the connection to the Toolkit to allow configuration to take place. See [Common Toolkit Pages - Home](#)

Settings

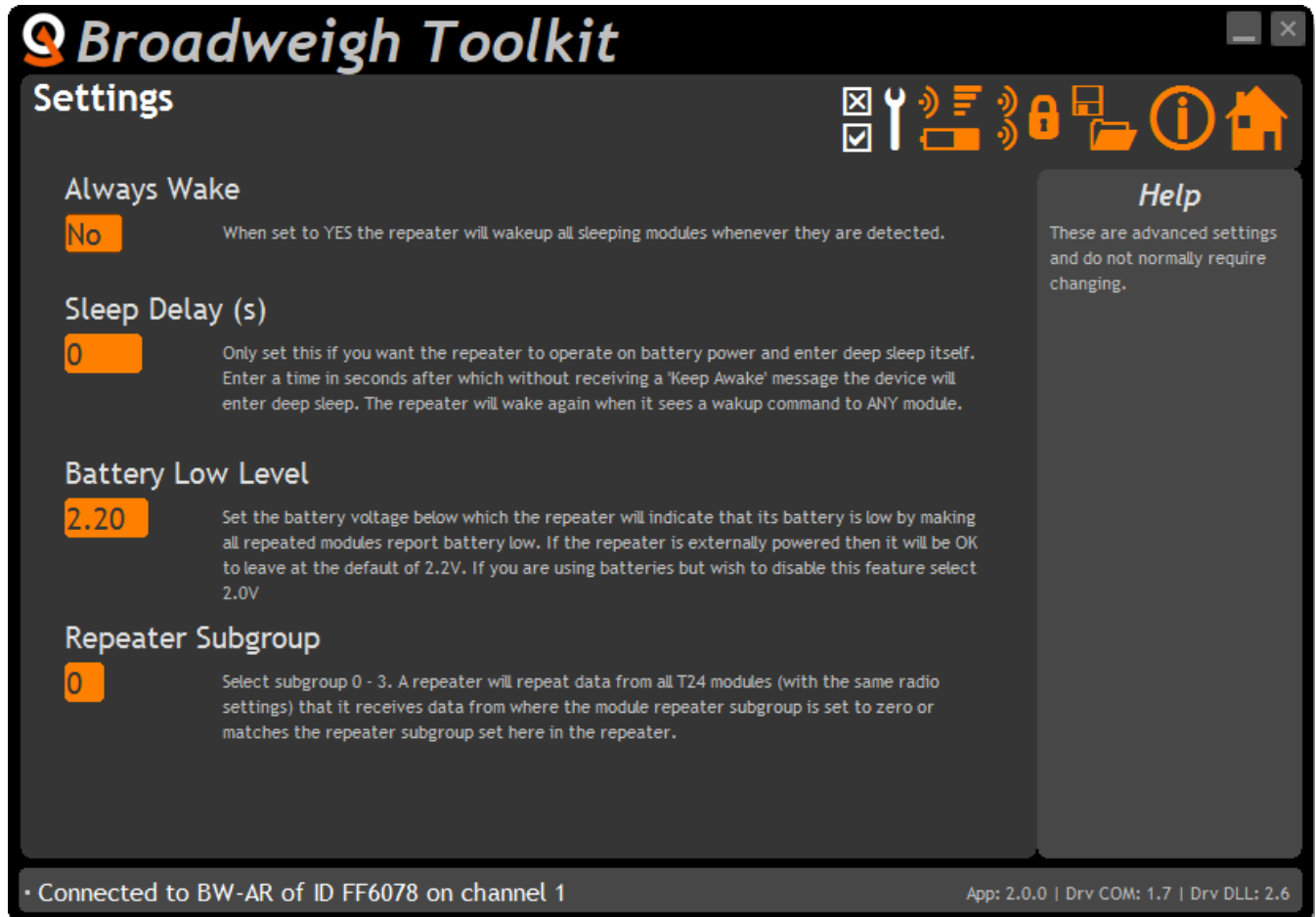

Here you can change the settings for the repeater.

Items you can change:

- | | |
|-------------------|---|
| Always Wake | In some cases where the repeater is manually powered on and off you may want it to wake all sleeping modules within its range. Set this option to Yes to enable this. The modules you wake should have their own Sleep Delay settings set so they go back to sleep after stopping receiving Stay Awake messages from the data consumer (PC or handheld). |
| Sleep Delay | If the repeater is to be battery powered and you want to operate in low power mode you can employ this delay. Once the repeater stops hearing Stay Awake messages from the data consumer (PC or handheld etc.) it will go to sleep after this amount of time. The repeater will wake when any other module is woken. Set to zero to disable. |
| Battery Low Level | Select the battery voltage below which the repeater will report a low battery. It does this by making all repeated modules report a low battery so the data consumer (a handheld or PC software etc.) will be able to detect a problem. The battery level applies to the voltage seen after 3 V regulation. The default is 2.2 V and can be left at this when the repeater is powered externally.

If the repeater is battery powered and you wish to disable this feature select 2.0 V |

Enclosure & Mounting

This module is fitted inside our large, 'ACM' ABS enclosure. Please see [Appendix A – B Style](#) for more information and optional mounting.

Antennas

These modules have the antenna already fitted inside the enclosure so there are no specific mounting requirements.

Radio Range

To determine radio range please refer to [Appendix B – Radio Range](#)

Specification

Environmental	Min	Typical	Max	Units
Operating temperature range	-40		+85**	°C
Storage temperature	-40		+85	°C
Humidity	0		95	%RH
Environmental protection with suitable cables exiting through cable glands.		IP67		

**Batteries used may have reduced operating temperature range.

Power Supply	Min	Typical	Max	Units
Standby / Low power mode		5	20	µA
Normal Mode on constantly		55	60	mA
Reverse Polarity Protection		-32		Vdc
Internal				
Battery Supply Voltage	2.1	3	3.6	Vdc
External				
Power Supply voltage	5		18	Vdc
Power Supply ripple			50	mV ac pk-pk

Battery Life	Typical	Units
Battery life using Duracell LR20 'D' cells with the BW-AR permanently activated. **	228 (10)	Hours (Days)

**Usually using batteries the BW-AR would be utilising the SleepDelay to return to sleep. Therefore the actual daily usage would allow for far greater than the stated battery life. For example: If the BW-AR was used for 1 hour per day then the battery life would be 6840 hours or 288 days or nearly 10 months.

Radio Range

To determine radio range please refer to [Appendix B – Radio Range](#)

Gateways

SS-GT24B-A

Overview

The SS-GT24B-A gateway can take data from up to sixty Broadweigh transmitter modules and deliver them to the SensorSpace® cloud platform for data storage, visualisation and analysis.

Using SensorSpace's point-and-click application development tools, create real-time dashboards to analyse data and control devices.

Visualise data with SensorSpace's graphs, charts, tables, indicators, maps, metrics, and control widgets or develop your own using the HTML canvas and your own code.

Share your data through public links, or by embedding dashboards or widgets into private web and mobile applications.

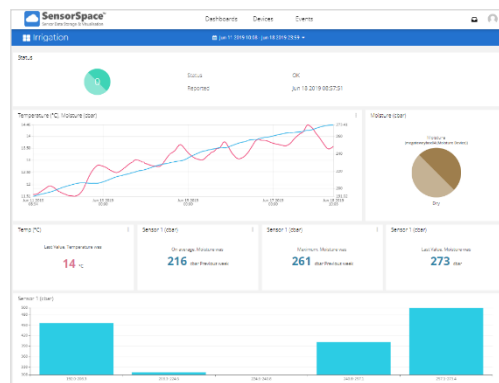

You will need an active plan in place on the SensorSpace platform. You will also need to refer to the SensorSpace User Manual to understand how to configure the SensorSpace platform to your requirements.

You can manually define a list of up to sixty (60) Broadweigh transmitters or let the gateway automatically add them as it finds them during the first 60 seconds after powering up (It is advised to use Group Keys so you only add your own transmitters). You can then define at what interval the values from the transmitters are sent to the cloud platform.

Each gateway has a unique serial number which is used as the device name which is automatically created on the SensorSpace platform.

The gateway will automatically create variables on the cloud which are named after the Data Tags of the Broadweigh transmitters. You can optionally select whether the values delivered are the last values seen by the gateway, a block average of all transmissions seen since last cloud delivery, or the minimum or maximum value seen since the last cloud delivery.



The gateway does not store Broadweigh data so if there is no connection to the SensorSpace platform then data will not be delivered during the disconnection. Data will **not** be retrospectively delivered once the connection is successfully restored.

Order Codes

SS-GT24B-A



This gateway uses an RJ45 Ethernet connector to connect to a wired network. The module enclosure is not weatherproof.

Connections

This diagram shows the available connections and switches.

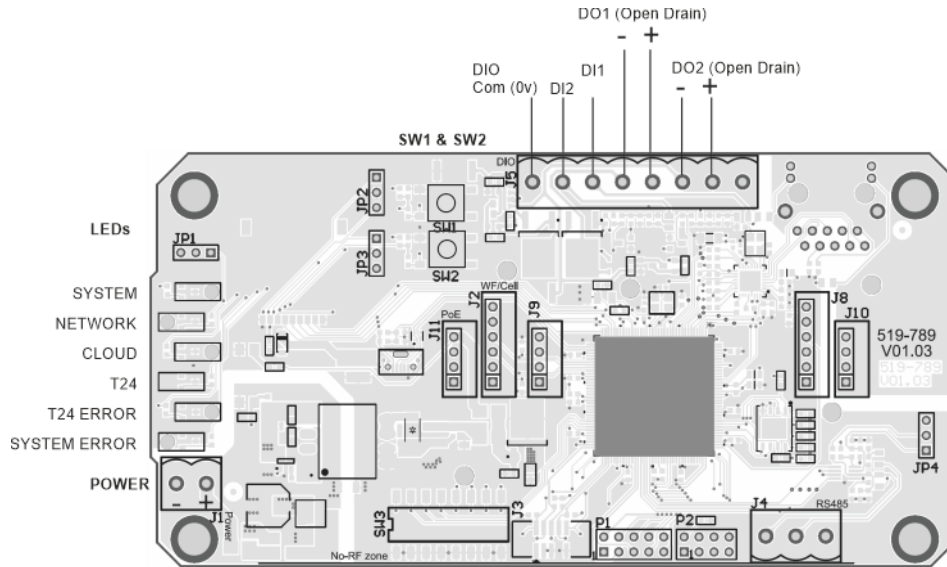

Power

The module is powered by 8 to 36 Volt DC external power supply.

Digital Inputs

DI1 and DI2 are voltage free inputs fitted with 1k internal pull-up resistors, activate by shorting the contact to Com (0V). The states of these inputs can optionally be delivered to the cloud platform. When the input is active a value of 1 will be delivered and a value of 0 when inactive. See below for a connection example.

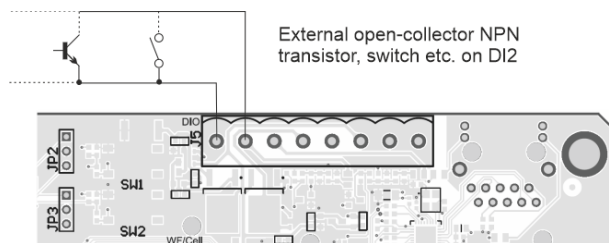

Digital Outputs

DO1 and DO2 outputs are open drain (MOSFET) and can be optionally configured to reflect the state of two variables on the cloud platform. These outputs may be used to drive additional relays or drivers to control devices such as valves, pumps, klaxons etc.

As the outputs are Open-Drain, the '+' connections of DO1 and DO2 should connect to the +ve supply of whatever is externally connected to the '-' pins in order to suppress inductive spikes when switching.

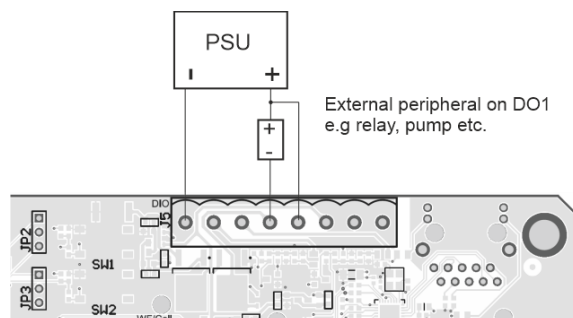

SW1 & SW2

Holding SW1 and SW2 while the module is powered up will clear the internal list of Data Tags that are monitored. This is useful if the module is used in Automatic input mode and you need to clear the list when the module is deployed at a new site. See [Inputs](#)

LED Indication

The LEDs are visible with the lid on or off.

Slow flashing LED is on for approximately one second then off for approximately one second.

Fast flashing is when the LED flashes every second.

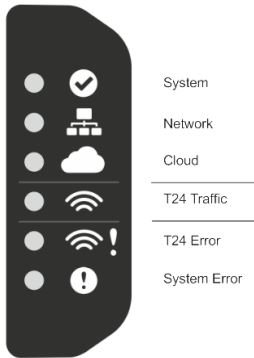

System



Slow flash while the module is starting up.



Brief flashing when successful.



Network



Slow flash while connecting to the network or the connection has dropped and the gateway is retrying.



Flashing when successfully connected to the network



Cloud



Off when waiting for a Network connection and checking Internet connectivity.



Slow flash while connecting to the SensorSpace platform or the connection has dropped and the gateway is retrying.



Flashing when successfully connected.



T24 Traffic



Flashes briefly when T24 data arrives.



T24 Error



Off when there are no errors with remote T24 transmitters.



Slow flash indicates that at least one transmitter is reporting a low battery.



Flashing indicates that one or more transmitters are reporting an error or have timed out.



System Error



Off when there are no errors.



Slow flash indicates a critical issue with the flash memory of the gateway and indicates that the device needs to be returned for repair or investigation.



Flashing indicates an error has occurred so look at other LEDs or connect to Toolkit to determine where the fault may lie. This may indicate a temporary disconnection from either SensorSpace platform, the internet in general or the network itself (Ethernet).

Configuration

The Broadweigh Toolkit provides a means of simple configuration of the gateway module along with useful tools to aid integration.

Launch the Broadweigh Toolkit software application and pair to this module to enable the connection to the Toolkit to allow configuration to take place. [See Common Toolkit Pages - Home](#)

Status

Broadweigh Toolkit

Status

Device **MEGatewayBox01** A device with this name will be created on the cloud platform

Network **Connected** Status of network connection

Cloud **Connected** Status of cloud platform

Log

```
18/01/2021 14:41:37 : MQTT service is subscribing to topics
18/01/2021 14:41:37 : MQTT service has subscribed to topics
18/01/2021 14:41:37 : MQTT service is subscribing to topics
18/01/2021 14:41:37 : MQTT service has connected to broker
18/01/2021 14:41:36 : MQTT service is connecting to broker
18/01/2021 14:41:36 : Connection to the Internet has been confirmed
18/01/2021 14:41:36 : SNTP service has started
18/01/2021 14:41:36 : +ve correction applied to RTC
01/01/2000 00:00:10 : SNTP service is starting
01/01/2000 00:00:10 : Attempting connection to the Internet
01/01/2000 00:00:10 : Network service has started
01/01/2000 00:00:10 : IP address received from DHCP server
01/01/2000 00:00:10 : IP address has changed
01/01/2000 00:00:10 : DHCP state: BOUND
01/01/2000 00:00:10 : DHCP state: REQUESTING
01/01/2000 00:00:08 : DHCP state: SELECTING
01/01/2000 00:00:07 : DHCP state: INIT
```

Clear Copy

Digital IO

- Output 1 (DO1)
- Output 2 (DO2)
- Input 1 (DI1)
- Input 2 (DI2)

Help

View the status of network and cloud connections. Note that the log only fills while on this tab. The state of the digital inputs and outputs can also be monitored.

Connected to SS-GT24 of ID FDCC5F on channel 1

App: 02.10.06 | Drv COM: 2.0 | Drv DLL: 2.7

Here you can view the status of the gateway.

Items you can change:

- Device** This displays the name of the device that will be created in SensorSpace. This is the serial number of the module prefixed with 'h-'
- Network** Indicates whether the gateway is connected to the network.
- Cloud** Indicates whether the gateway is connected to the SensorSpace cloud platform.
- Log** The log list will display information from the gateway and will be timestamped by the Toolkit as each message is received. Note that the gateway can store multiple messages so that even if the Toolkit is connected (By a soft pair) after the gateway has already started it can still extract and display the messages raised during startup. NOTE: in this case all the timestamps will be similar because the messages will have been received at the same time. Future releases of the gateway will timestamp the messages with the actual time the message was logged.

Clear	Clear the messages from the log list.
Copy	Copy the log list to the clipboard.
Output 1 (DO1)	Indicates that digital output 1 is active when the displayed circle is filled.
Output 2 (DO2)	Indicates that digital output 2 is active when the displayed circle is filled.
Input 1 (DI1)	Indicates that digital input 1 is active when the displayed circle is filled.
Input 2 (DI2)	Indicates that digital input 2 is active when the displayed circle is filled.

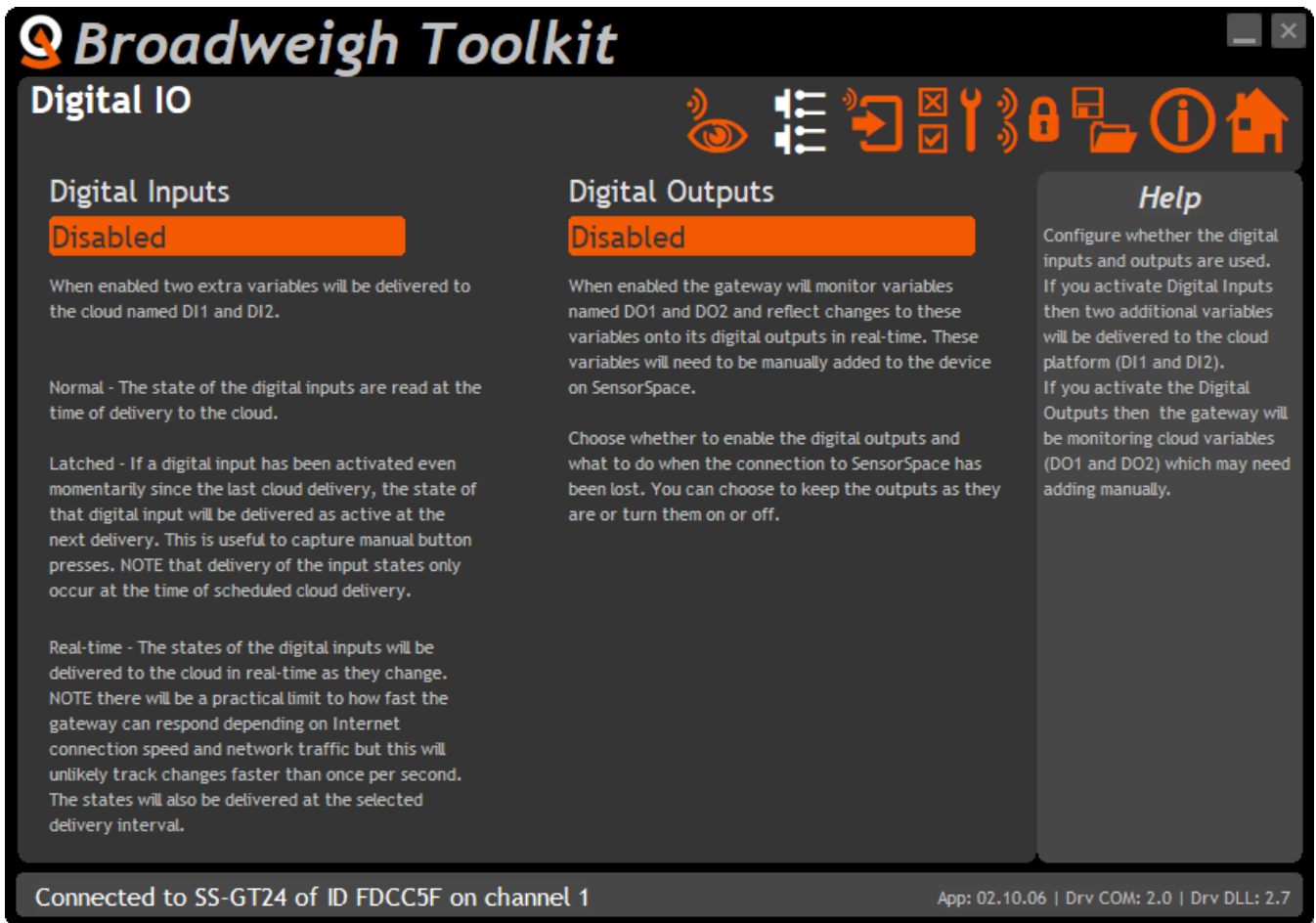

Here you can choose how to work with digital inputs and outputs..

Items you can change:

- Digital Inputs
 - The state of the two digital inputs can be optionally delivered to SensorSpace and the way the state is delivered can also be defined.
 - When the Digital Inputs are not Disabled then the variables **DI1** and **DI2** will be delivered to SensorSpace where a value of 0 indicated input is inactive and a value of 1 indicates it is active.
 - The options are:
 - Disabled** – The variables are not delivered to SensorSpace.
 - Normal** – The state of the digital inputs at the time of the normal scheduled delivery to SensorSpace will be delivered as **DI1** and **DI2**.
 - Latched** – If a digital input has been activated at least once since the last delivery then the state of the digital input will be delivered as active.
 - Real-time** – The state of the digital inputs will be delivered to SensorSpace in real-time as they change state. Do not expect that the gateway will be able to track input changes faster than once per second.

Digital Outputs

By creating two raw variables named **DO1** and **DO2** in the device on SensorSpace you can optionally enable the state of these variables to be immediately reflected in the digital outputs on the gateway. A variable value of **zero** will deactivate the digital output and a variable value of **1** will activate the digital output.

The options are:

Disabled – Do not use the digital outputs.

Enabled – Leave on Error – Enable the digital outputs and if the connection is lost with SensorSpace just leave the digital outputs in their current state.

Enabled – Off on Error - Enable the digital outputs and if the connection is lost with SensorSpace deactivate the digital output.

Enabled – On on Error - Enable the digital outputs and if the connection is lost with SensorSpace activate the digital outputs.

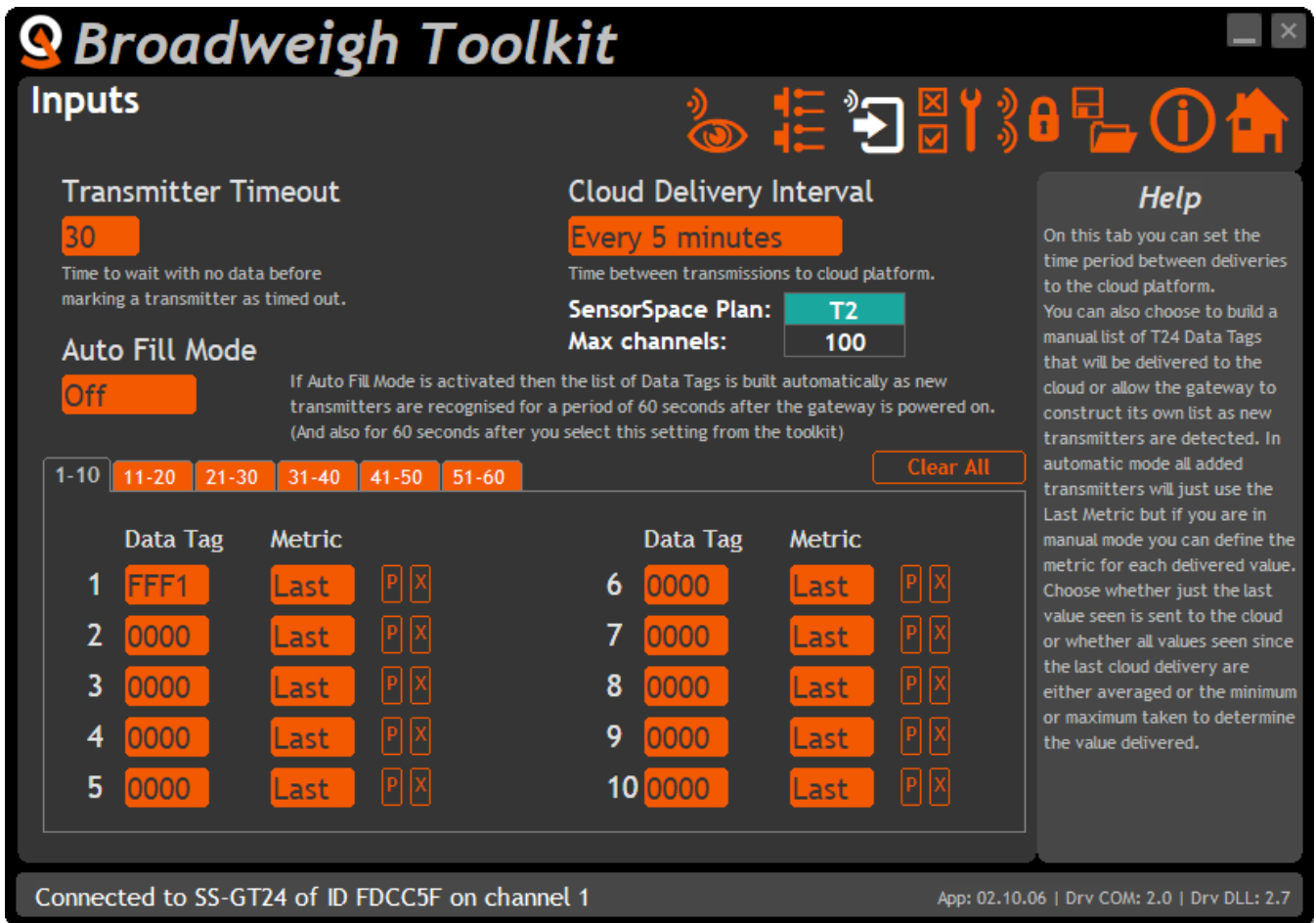

Here you can set timeouts and specify transmitters (Shackles and other modules) and also choose the interval between deliveries of data to the cloud platform.

Items you can change:

- Transmitter Timeout** Enter the maximum time to wait for data from a transmitter before indicating that the transmitter has timed out by sending the new status to the cloud platform and indicating errors on the LEDs.
- Cloud Delivery Interval** Choose the interval between sending the transmitter data to the cloud platform.
- Auto Fill Mode** When this mode is turned on the gateway will automatically search for new transmitters and add them to the transmitter list for the first minute after being powered up. This mode is useful if you intend to add more transmitters to a site in the future without having to reconfigure the gateway. The search for new modules is also initiated (for a minute) when you change this setting from Off to On.
- Data Tag** Use the tabs to access blocks of transmitters to access their data. Only the Data Tags may be filled automatically when Auto Fill Mode is active. Enter the 4 character hexadecimal Data Tag of the required transmitter. This Data Tag will be used as the Variable name that is created on the SensorSpace cloud platform in this device.

Metric	<p>Here you can select how the gateway deals with all the data received by the transmitters between the times it needs to transmit the data to the cloud platform. The choices are:</p> <p>Last – Just deliver the last value received from the transmitter.</p> <p>Avg – Block average all received values and send the average result to the cloud.</p> <p>Min – Send the minimum value received to the cloud.</p> <p>Max – Send the maximum value received to the cloud.</p>
P	<p>This is a helper function to retrieve the Data Tag from a transmitter and enter it into the Data Tag field. Click the P button then power cycle the transmitter to pair to it and retrieve the Data Tag. NOTE: pairing will switch the RF channel and Group Key of the base station to match the paired transmitter.</p>
X	<p>Set the Data Tag to 0000 which represents unused.</p>
Clear All	<p>This will remove all configured Data Tags. This can also be achieved by holding down both buttons on the PCB of the gateway whilst applying power.</p>

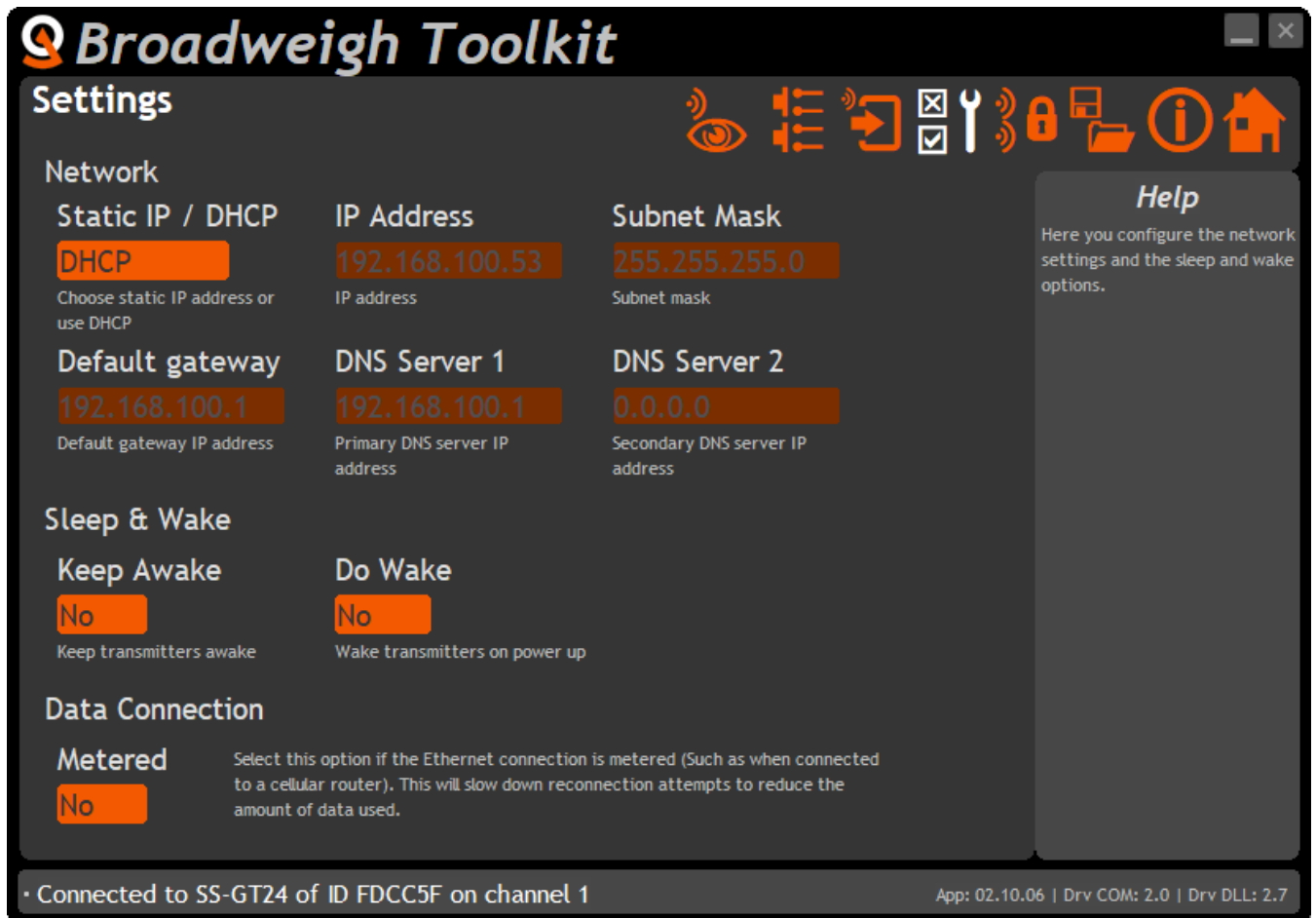

This page allows you to configure the Ethernet network settings and the wake functions.

Items you can change:

Network

Static IP / DHCP Choose Static to manually enter all IP addresses. Choose DHCP to have the IP addresses assigned automatically by the DHCP server.

IP Address This shows the currently allocated IP address in DHCP mode or your manually entered address in Static mode.

Subnet Mask This shows the currently allocated Subnet Mask IP address in DHCP mode or your manually entered address in Static mode.

Default Gateway This shows the currently allocated Default Gateway IP address in DHCP mode or your manually entered address in Static mode.

DNS Server 1 This shows the currently allocated Primary DNS Server IP address in DHCP mode or your manually entered address in Static mode.

DNS Server 2 This shows the currently allocated Secondary DNS Server IP address in DHCP mode or your manually entered address in Static mode.

Sleep & Wake

Keep Awake Periodically transmit Keep Awake messages to transmitter to stop them going to sleep if their Sleep Delays are set.

Do Wake

Broadcast wakes all transmitters on the same RF channel and using the same Group Key as the gateway when the gateway starts up.

Enclosure & Mounting

This module is fitted inside our ACM ABS enclosure. Please see [B Style \(ACM\)](#) for more information.

Antennas

These modules have the antenna already fitted inside the enclosure so there are no specific mounting requirements.

Specification

Parameter	Minimum	Typical	Maximum	Units
External Supply voltage Range	9	12	36	Vdc
Average Operational Current	-	100	-	mA
Operating Temperature Range	-20	-	55	°C
Storage Temperature Range	-40	-	85	°C
Reverse polarity Protection		-	-32	V
Humidity	0		95	%RH
IP Rating		IP54		

* At 12 Volt nominal Supply

Radio Range

To determine radio range please refer to [Appendix B – Antenna Range](#)

Power Supply Modules

PP1 & SP1

Overview

The Power Pack (PP1) & Solar Panel 1 (SP1) provides dependable off-grid power generation and storage to support a variety of products.

Packaged in an IP67 sealed case with rugged waterproof connectors the PP1 has two sources of charge for the internal battery with both solar and mains power input charging. The case also features Stainless steel padlock protectors for easily securing your supply on site.

The PP1 has a single 12 V fuse protected output. The mating connector comes pre-fitted with 5 metres of cable and bare end connections.

The solar panel features hail-proof tempered glass and closely packed polycrystalline cells, sealed into a robust aluminium frame. The junction box on the rear of the panel does not protrude beyond the frame, so installation can be simple and neat. The solar cell comes with 5 metres of cable as standard.

The SP1 & PP1 combined are designed to provide a perpetual power supply for a 12 V system drawing an average of 53 mA, even during winter.

The PP1 can also be used as a mains powered 12 Vdc supply with 33 Ah battery backup.

Order Codes

PP1



Power pack 1 housed in robust weatherproof case.

SP1



Solar panel with cable suitable for connection to PP1

Getting Started

It is important when using the PP1 in any configuration that the connections are made in the following order:

1. Connect the 12 V output lead to the device you wish to supply. The PP1 is provided with a 5 metre 12 V output cable, this cable has the IP67 connector which mates with connection 3, see below. The cable is bare end terminated the red wire is positive and black is ground. Ensure the bare end connections are made before attaching to the PP1.
2. Connect the Solar Panel. The solar panel is supplied with a 5 m cable terminated with the IP67 connector which mates with connection 1, see below.
3. Connect 100-240 Vac supply (if necessary) The PP1 is supplied with a 0.8 m mains cable with a 13 A plug. The battery inside the PP1 will be supplied fully charged.



Power Pack 1 Connections

1. Solar Panel Input
2. 100 – 240 volt AC input
3. 12 volt DC Output
4. 1.0 amp Anti-surge Fuse

Installation

Connecting Power Pack 1

All connectors on the SP1 and PP1 are IP67 rated when correctly mated. The PP1 case is also IP67 rated meaning it is protected against the effects of temporary immersion in water between 15 cm and 1 m for no longer than 30 minutes. Dust caps must be fitted properly if the connection is not being used. If possible avoid positioning the PP1 in direct sunlight to limit temperature effects on the battery.

The connections for the solar panel input and 12 V output feature a locking collar to ensure the connection is sealed. To insert remove the dust cap and align the connector and insert; there is a locating ridge to ensure correct orientation. Once inserted, twist the collar clockwise to lock in place. The connectors for the solar panel and 12 V output are opposite gender preventing incorrect connections.



The PP1 110 - 240 Vac input has a sealing cap for when it is not connected to the mains. The sealing cap is removed by pushing the outer sleeve towards the case and pulling the cap out.



To insert the mains cable input simply align the two parts using the locating grooves on the connector and push in until the outer sleeve locks; to remove again repeat the same procedure as to remove the sealing cap.

Solar Panel Orientation

The SP1 is supplied on a mounting plate which when assembled with the horizontal support holds the panel at 50 degrees. The bracket is designed to be mounted on a pole or directly onto a wall.

For detailed panel angle information based on country and location see Solar Electricity Handbook calculator here:

<http://www.solarelectricityhandbook.com/solar-angle-calculator.aspx>

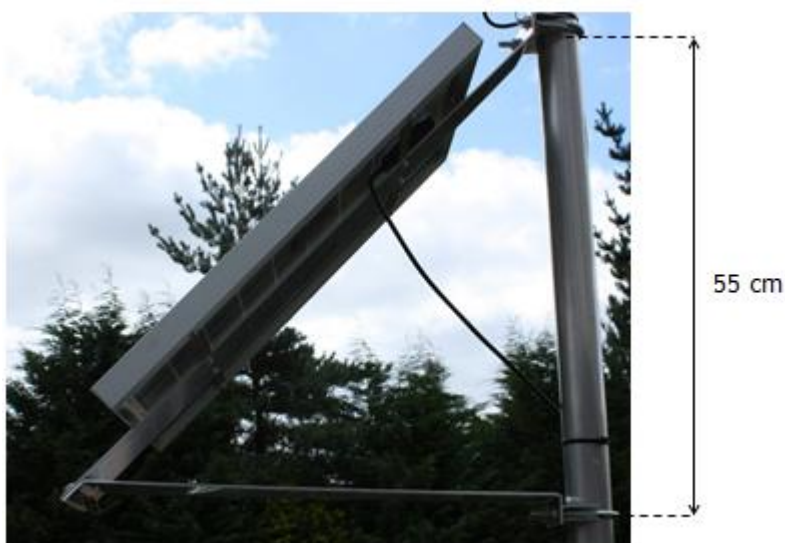

When positioning the solar panel it should always face true south if you are in the northern hemisphere, or true north if you are in the southern hemisphere. True north is not the same as magnetic north. If you are using a compass to orient your panels, you need to correct for the difference, which varies with location. Search the web for “magnetic declination” to find the correction for your location.

Also consider where shadows may fall on the solar panel, the panel needs maximum exposure to the sun to operate as specified.

Operation

The PP1 and SP1 combination was designed to supply a 12 V system with a maximum continuous average current consumption of 53 mA. The power rating of the system would be 0.636 W; if used 24 hours per day this would equate to 15.264 watt-hours. On an average British day, this power could be produced by a solar panel array of approximately 6 watts. However, you do of course get more power in the middle of summer than in winter. In summer you could produce that power required with only 3 watts of solar panels. In winter you would need 15 watts of panels to produce enough power. Hence the SP1 20 W panel is more than adequate.

The output from the PP1 is fuse protected by a 1.0 A anti surge fuse, this is to protect against short circuit on the output, fuses are 1.0 A 20x5 mm ceramic glass tube type. The 100-240 Vac input charger is fuse protected in the 13 amp plug, if this plug is replaced with any other connector please consider how your PP1 is protected.

Dimensions & Weight

PP1 Dimensions	339 x 295 x 152 mm
PP1 Case materials	Polypropylene
PP1 Weight	13 kg
SP1 Dimensions	360 x 510 x 28 mm
SP1 Frame Material	Aluminium
SP1 Weight	3 kg



Specifications

Electrical	Min	Typical	Max	Units
Output Voltage		12		Vdc
Internal Capacity		33		Ah
External Power Supply Voltage	100	-	250	Vac
Input Frequency	47	-	63	Hz

Cable Lengths			
12 V Output Cable to Bare End		5	m
Solar Panel to Power Pack		5	m
Mains Charging cable *		0.8	m

* Supplied with 13 Amp Plug

Environmental			
IP rating		IP67	
Operating temperature range **	-20		+50 °C
Storage temperature	-20		+50 °C
Humidity	0		95 %RH

** When being charged from Mains min operating temperature 0 °C max operating temperature is 40 °C

Appendices

Appendix A – Enclosures

K Style (Handheld 2025)

Dimensions

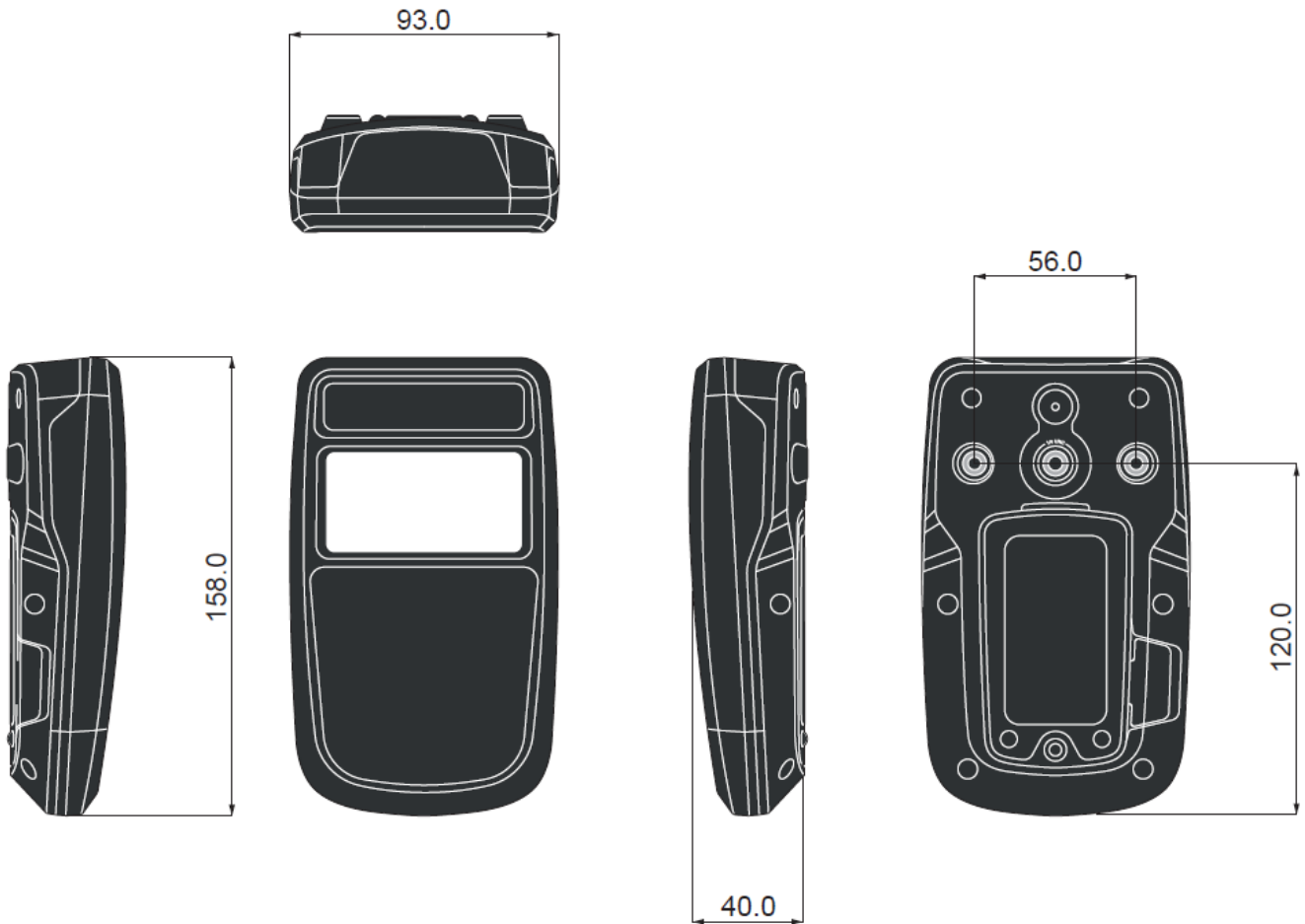

Opening the case

The batteries are accessed by removing the single rear screw.
Before reattaching the battery cover check the seals and grooves for debris and damage.

! The battery cover should remain with the handheld case that it was shipped with.

The rest of the case should not be opened.

Mounting information

There is a ¼" UNC thread on the rear of the handheld for mounting using a camera style fixing.
There are also two holes that accept a no. 2 self tapping screw.

Antenna position

The enclosure is fitted with a T24-ANTA antenna which is mounted in the top end of the enclosure, above the display.

Environmental protections

The enclosure is sealed to IP67. Ensure gaskets and mating parts are free from dirt and debris when reassembling.

A Style (Handheld)



Dimensions

This ABS handheld case is 152 mm X 90 mm and 34 mm deep at its highest section.

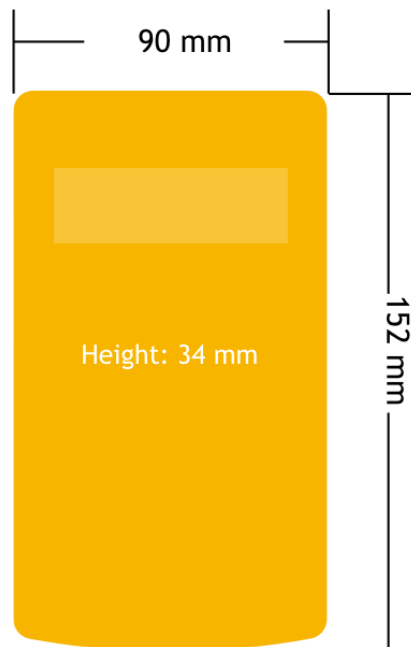

Opening the Case

The battery compartment is secured with two Philips head screws.

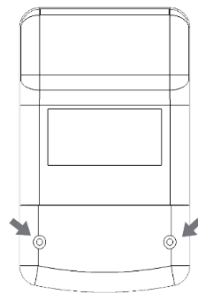

Once the battery compartment has been removed this gives access to two further screws which can be removed (along with the two at the top end) to allow the entire case to come apart. This gives access to the legend channels where cardboard legends can be slipped in behind the transparent label windows where supported. Note that the top two screws will have rubber 'O' rings on them. These rings are an integral part of the sealing mechanism.

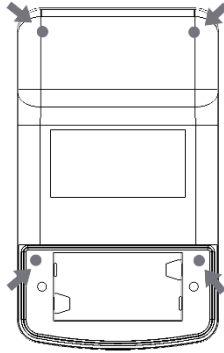

When the case comes apart be careful of any wires running between the two case halves.

Mounting Information

There are no mounting options on the handheld enclosure.

Antenna Position

The enclosure is fitted with a BW-ANTA antenna which is mounted in the top end of the enclosure.

Environmental Protection

The enclosure is sealed to IP67. Ensure gaskets and mating parts are free from dirt and debris when re-assembling.

B Style (ACM)



Dimensions

This ABS enclosure measures 164mm X 84mm and 57mm deep. There are three positions for cable glands; two at one end and one at the other. Different modules may have a different number of glands fitted.

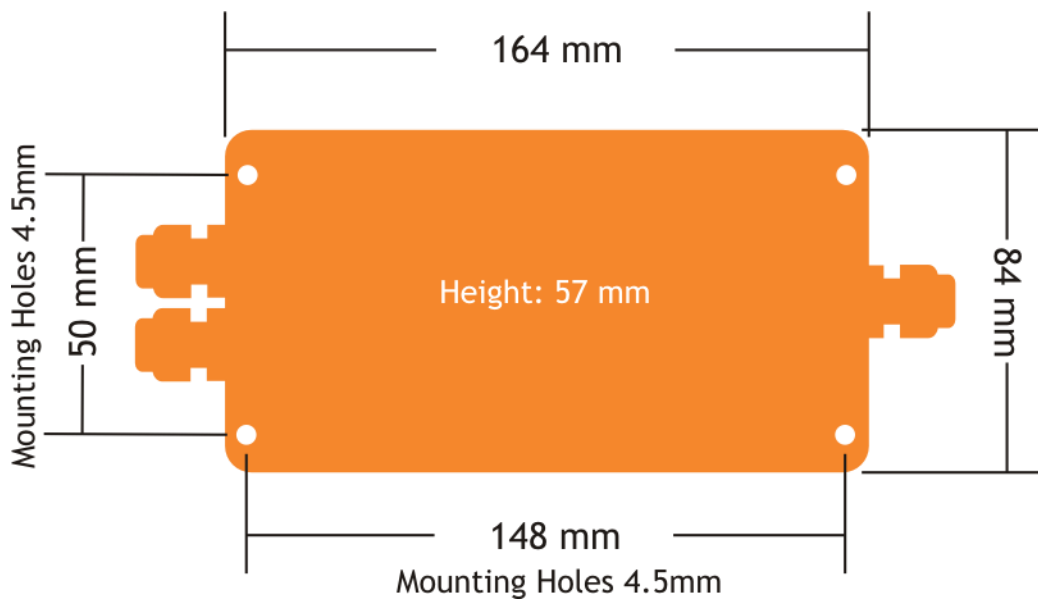

Opening the Case

The case lid is secured with 4 x ¼ turn quick release screws. Using a flat head or Phillips screwdriver push down and turn each screw by 90° anticlockwise to release.

Mounting Information

This enclosure is designed to be mounted to a surface. It is secured by holes on a 148 mm X 50 mm rectangle. The mounting holes are accessible once the lid has been removed and these are outside the sealing mechanism. Mounting holes have a diameter of 4.1 mm and can accommodate a screw head diameter of 6.8 mm.

Optional Mounting Kit

An optional mounting kit is available for this enclosure type to allow fitting to 50mm scaffold poles (As fitted to the wind speed transmitter)

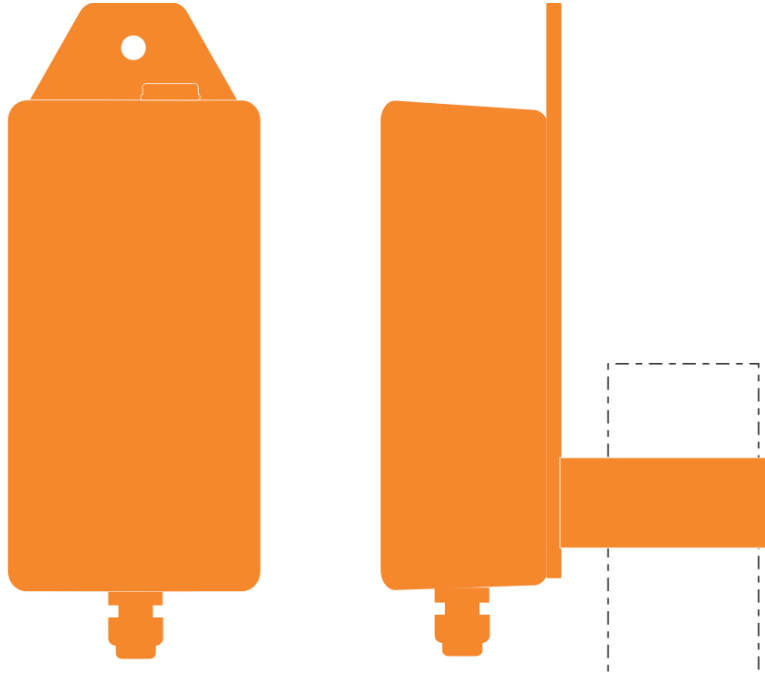

Antenna Position

The module is fitted with a BW-ANTA antenna which is mounted on the inside of the long side of the base on the opposite side of the enclosure to the metallised polyester label visible on the outside.

Environmental Protection

The case is environmentally sealed to IP67 and the glands sealed to IP67 when cables of the correct diameter have been used.

The cable diameter can range from 4mm to 8mm. Cables of a smaller diameter may be used if sleeved to increase their diameter.

When mounting the enclosure outside the cables should be dressed to provide a drip loop.

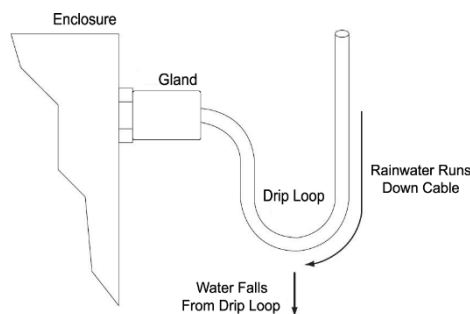

The sealing gasket resides in the lid. Be careful when replacing the lid that there are no dirt particles on the lower case lip or in the lid gasket channel as this may reduce the sealing capability.

C Style (ACMi)



Dimensions

This enclosure is 76.6 mm X 59 mm and 31 mm deep. The gland extends a further 25 mm from one long side.

Opening the Case

The case lid is secured with 4 x #2 cross head screws, remove the four screws and apply pressure in either off set corner fixing to lift lid.

Mounting Information

The enclosure has two mounting holes as shown below; these mounting holes are external to the seal but still covered by the case lid to offer fixings for some environmental protection. In addition mountings can be made through the back of the case however a seal or gasket must be used to maintain environmental protection.

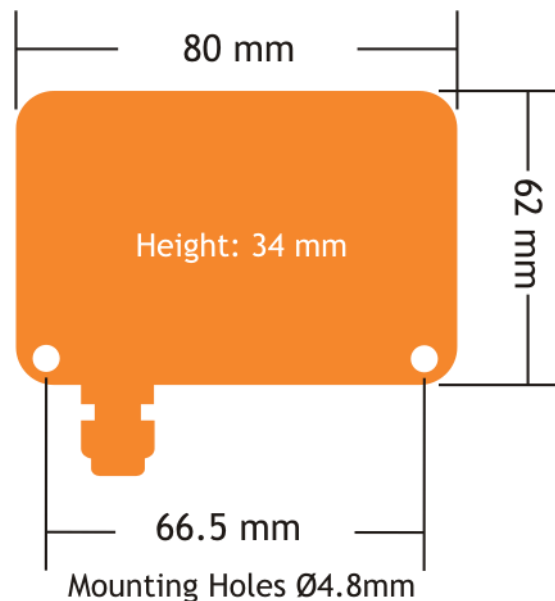

Antenna Position

This enclosure is fitted with a PCB antenna which sits over the wiring access chamber and is covered by the enclosure lid.

Environmental Protection

The case is environmentally sealed to IP67.

The sealing gasket resides in the base. Be careful when replacing the lid that there are no dirt particles on the gasket channel or lid as this may reduce the sealing capability.

When mounting the enclosure outside the cables should be dressed to provide a drip loop.

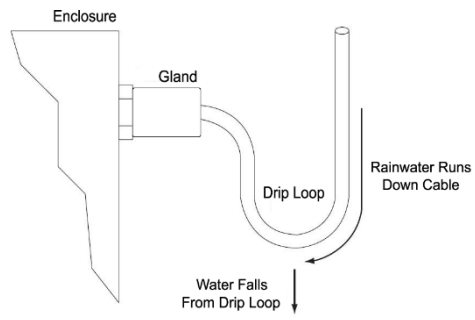

The sealing gasket resides in the base. Be careful when replacing the lid that there are no dirt particles on the lid lip or in the case gasket channel as this may reduce the sealing capability.

H Style (Dongle)



Dimensions

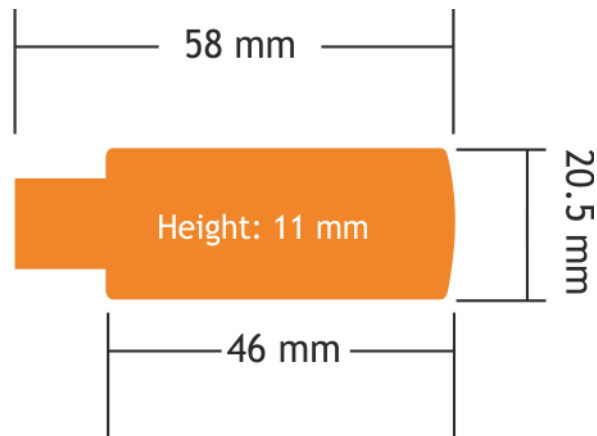

Opening the Case

The case is not designed to be opened.

Mounting Information

There are no mounting options. This style enclosure plugs directly into a USB port or alternatively into the end of a USB extension cable.

Antenna Position

The enclosure is fitted with an integrated chip antenna which is mounted in the top end of the enclosure opposite to the USB connector.

Environmental Protection

This enclosure is not weatherproof.

Appendix B – Radio Range

Overview

Radio performance at microwave wavelengths is very dependent upon the operating environment; any structure within the operating region of the radios will give rise to three effects:

Obscuration. Obscuration will result in reduced range and occurs when an obstruction masks the line-of-sight between radios.

Aberrations to the horizontal and vertical space patterns. Distortion of these patterns may occur if structures or objects are placed in the near or intermediate field of the antenna. The effect will be to distort the coverage patterns, adversely affecting range and link quality.

Reflection. Any object placed in line-of-sight of the transmit antenna will result in signals arriving at the receiver by an indirect path. Degradation of performance due to reflection (multipath effects) appears as reduced range or poor link quality.

Any of the above will cause poor RSSI figures, an increase in the packet loss rate and in extreme cases complete loss of signal. Fortunately, if consideration is given to these effects at the integration stage then a good quality link will be obtained.

Guidelines for installation:

When planning installations ensure that line-of-sight between nodes is maintained and that objects or structures are kept at least one metre away from antennae wherever possible.

Range

Radio range has been measured as 800 m line of sight in an open field site where the transmitter was 3 m from the ground and the receiver was 1.5 m from the ground.

This range will be reduced when transmitters or receivers are close to metallic structures or close to the ground.

Walls and floors will also reduce the achievable range in indoor environments.

 BW-BSd has a range of 500 m

 Modules manufactured before July 2015 have a range of 200 m

 In regions where FCC transmission power levels are allowed the Broadweigh toolkit allows radio modules to be power boosted to within acceptable FCC power density limits. This will reduce battery life but will give a range of 1.4 km

Appendix C - Radio Specification

The following specification applies to all Broadweigh modules.

	Min	Typical	Max	Units
License		License Exempt		
Modulation method		MS (QPSK)		
Radio type		Transceiver (2 way)		
Data rate		250		k bits/sec
Radio Frequency	2.4000		2.4835	GHz
Power		10		mW
Channels (DSSS)		15		

For radio range information See [Appendix B – Antenna Range](#)

Appendix D – Conditions of Use

The working load limit (WLL) of Broadweigh shackles and TwistLinks assumes the absence of exceptionally hazardous conditions. These include offshore activities, lifting of persons and lifting of potentially dangerous loads such as molten metals. With every use the degree of hazard should be assessed by a competent person and the safe working load (SWL) reduced accordingly from the working load limit.

Please remember that Broadweigh does not give advice as to how the data from Broadweigh shackles is used. All lifting operations are different and must be supervised by suitably qualified and experienced riggers. It is the user's responsibility to ensure conformity with local regulations and legislation.

Broadweigh requires that the integrator fully assess product suitability as part of any control system and that Broadweigh products are used within their published parameters at all time.

Broadweigh bows are subjected to a 200% proof load (static test coefficient of 2) and Broadweigh pins are subjected to a 150% proof load (static test coefficient of 1.5) before being calibrated as a whole assembly. However the product should never be used above the WLL. If the WLL is exceeded the unit should be removed from use and a Broadweigh representative contacted. When **Gen 3** shackles are paired in the Toolkit, you can see the highest measured load that the shackle has seen. If this is greater than the WLL of the shackle it must be returned to Broadweigh for evaluation to ensure its continued safety.

Appendix E – Approval Statements

CE



Complies with EMC directive. 2014/30/EU
The Radio Equipment Directive, 2014/53/EU,

European Community, Switzerland, Norway, Iceland, and Liechtenstein

English:	This equipment is in compliance with the essential requirements and other relevant provisions of Directive 1999/5
Deutsch:	Dieses Gerät entspricht den grundlegenden Anforderungen und den weiteren entsprechenden Vorgaben der Richtlinie 2014/53/EU.
Dansk:	Denne udstyr er i overensstemmelse med de væsentlige krav og andre relevante bestemmelser i Direktiv 2014/53/EU.
Español:	Este equipo cumple con los requisitos esenciales así como con otras disposiciones de la Directiva 2014/53/EU.
Français:	Cet appareil est conforme aux exigences essentielles et aux autres dispositions pertinentes de la Directive 2014/53/EU.
Íslenska:	Þessi búnaður samrýmist lögboðnum kröfum og öðrum ákvæðum tilskipunar 2014/53/EU.
Italiano:	Questo apparato è conforme ai requisiti essenziali ed agli altri principi sanciti dalla Direttiva 2014/53/EU.
Nederlands:	Deze apparatuur voldoet aan de belangrijkste eisen en andere voorzieningen van richtlijn 2014/53/EU.
Norsk:	Denne utstyret er i samsvar med de grunnleggende krav og andre relevante bestemmelser i EU-direktiv 2014/53/EU.
Português:	Este equipamento satisfaz os requisitos essenciais e outras provisões da Directiva 2014/53/EU.
Suomalainen:	Tämä laite täyttää direktiivin 2014/53/EU oleelliset vaatimukset ja on siinä asetettujen muidenkin ehtojen mukainen.
Svenska:	Denna utrustning är i överensstämmelse med de väsentliga kraven och andra relevanta bestämmelser i Direktiv 2014/53/EU.

This equipment is in compliance with the essential requirements and other relevant provisions of Directive 2014/53/EU.

Alternative antennas may be used but those with a gain exceeding 3 dBi are strictly prohibited.

Manufactured in the UK by: Mantracourt Electronics Ltd, The Drive, Farringdon, Exeter, Devon, EX5 2JB, UK



IC:7224A-RA24

This device complies with Industry Canada licence-exempt RSS standard(s). Operation is subject to the following two conditions: (1) this device may not cause interference, and (2) this device must accept any interference, including interference that may cause undesired operation of the device.

Under Industry Canada regulations, this radio transmitter may only operate using an antenna of a type and maximum (or lesser) gain approved for the transmitter by Industry Canada. To reduce potential radio interference to other users, the antenna type and its gain should be so chosen that the equivalent isotropically radiated power (e.i.r.p.) is not more than that necessary for successful communication.

This radio transmitter RA24 has been approved by Industry Canada to operate with the antenna types listed below with the maximum permissible gain and required antenna impedance for each antenna type indicated. Antenna types not included in this list, having a gain greater than the maximum gain indicated for that type, are strictly prohibited for use with this device.

Antenna	Gain (dBi)	Antenna Type	Manufacturer/Vendor
Ant A	3	Inverted F	Mantracourt
Ant C	2.2	½ wave Dipole	Mantracourt
Integrated	1.3	Chip antenna	Mantracourt

To comply with Industry Canada RF radiation exposure limits for general population, the antenna(s) used for this transmitter must be installed such that a minimum separation distance of 5 cm is maintained between the radiator (antenna) and all persons at all times and must not be co-located or operating in conjunction with any other antenna or transmitter.

Manufactured in the UK by: Mantracourt Electronics Ltd, The Drive, Farringdon, Exeter, Devon, EX5 2JB, UK



Family: RA24
Models: i and e

FCC ID: VHARA24

This device complies with Part 15 of the FCC Rules.

Operation is subject to the following two conditions:

- (1) This device may not cause harmful interference, and
- (2) This device must accept any interference received, including interference that may cause undesired operation.

This equipment complies with FCC radiation exposure limits set forth for an uncontrolled environment. End users must follow the specific operating instructions for satisfying RF exposure compliance. This transmitter must not be co-located or operating in conjunction with any other antenna or transmitter.

Changes or modifications not expressly approved by the party responsible for compliance could void the user's authority to operate the equipment

For use with antennas: integrated, T24-ANTA, T24-ANTB, T24-ANTC, T24-ANTD, T24-ANTE antennas and those listed in the table below.

Manufacturer Code	Description	Gain	Available From
DELTA7A	Dual band 2.4 or 5.8GHz Hinged mount whip	2.1dBi	Sequoia
DELTA14	Stubby WiFi / WLAN Antenna	2.0dBi	Sequoia
DELTA15/SMAM/RA/RP11	2.4GHz Right angle RPSMA	2.0dBi	Sequoia
1699481	AUREL ANT.RP SMA 2.4GHz	2.0dBi	Farnell Electronic Components
537-785	EAD, FBKR35068-RS-KR WiFi Antenna	2.0dBi	RS Components

Manufactured in the UK by: Mantracourt Electronics Ltd, The Drive, Farringdon, Exeter, Devon, EX5 2JB, UK

Appendix F - OEM / Reseller Marking and Documentation Requirements

CE

The Broadweigh series has been certified for several European countries.

If the transmitter module is incorporated into a product, the manufacturer must ensure compliance of the final product to the European harmonized EMC and low-voltage/safety standards. A Declaration of Conformity must be issued for each of these standards and kept on file as described in Annex II of the R&TTE Directive. Furthermore, the manufacturer must maintain a copy of the Broadweigh device user manual documentation and ensure the final product does not exceed the specified power ratings, antenna specifications, and/or installation requirements as specified in the user manual. If any of these specifications are exceeded in the final product, a submission must be made to a notified body for compliance testing to all required standards.

OEM Labelling Requirements

The 'CE' marking must be affixed to a visible location on the OEM product.

The CE mark shall consist of the initials "CE" taking the following form:

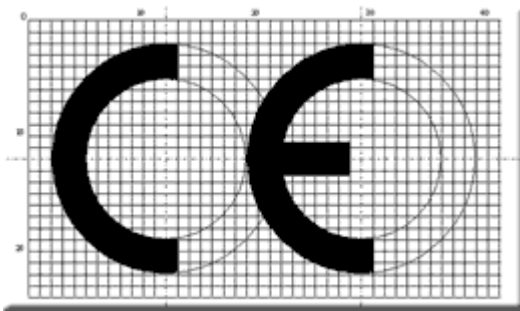

- If the CE marking is reduced or enlarged, the proportions given in the above drawing must be respected.
- The CE marking must have a height of at least 5 mm except where this is not possible on account of the nature of the apparatus.
- The CE marking must be affixed visibly, legibly, and indelibly.

IC

The RA24 Module has been certified for integration into products only by OEM integrators under the following conditions:

1. The antenna(s) must be installed such that a minimum separation distance of 5cm is maintained between the radiator (antenna) and all persons at all times.
2. The transmitter module must not be co-located or operating in conjunction with any other antenna or transmitter.

As long as the two conditions above are met, further transmitter testing will not be required. However, the OEM integrator is still responsible for testing their end-product for any additional compliance requirements required with this module installed (for example, digital device emissions, PC peripheral requirements, etc.).

IMPORTANT NOTE: In the event that these conditions cannot be met (for certain configurations or co-location with another transmitter), then Industry Canada certification is no longer considered valid and the IC Certification Number cannot be used on the final product. In these circumstances, the OEM integrator will be responsible for re-evaluating the end product (including the transmitter) and obtaining a separate Industry Canada authorization.

End Product Labelling

The RA24 Module is labelled with its own IC Certification Number. If the IC Certification Number is not visible when the module is installed inside another device, then the outside of the device into which the module is installed must also display a label referring to the enclosed module. In that case, the final end product must be labelled in a visible area with the following:

Contains Model RA24 Radio (2.4 GHz), IC:7224A-RA24

The OEM of the RA24 Module must only use the approved antenna(s) listed above, which have been certified with this module.

The OEM integrator has to be aware not to provide information to the end user regarding how to install or remove this RF module or change RF related parameters in the user's manual of the end product.

The user's manual for the end product must include the following information in a prominent location:

“To comply with Industry Canada RF radiation exposure limits for general population, the antenna(s) used for this transmitter must be installed such that a minimum separation distance of 5 cm is maintained between the radiator (antenna) and all persons at all times and must not be co-located or operating in conjunction with any other antenna or transmitter.”

FCC

The Original Equipment Manufacturer (OEM) must ensure that FCC labelling requirements are met. This includes a clearly visible label on the outside of the final product enclosure that displays the contents as shown:

Contains FCC ID:VHARA24

- This device complies with Part 15 of the FCC Rules.
Operation is subject to the following two conditions:
(1) This device may not cause harmful interference, and
(2) This device must accept any interference received, including interference that may cause undesired operation.
- This equipment complies with FCC radiation exposure limits set forth for an uncontrolled environment. End users must follow the specific operating instructions for satisfying RF exposure compliance. This transmitter must not be co-located or operating in conjunction with any other antenna or transmitter.
- Changes or modifications not expressly approved by the party responsible for compliance could void the user's authority to operate the equipment

When integrated in OEM products, fixed antennas require installation preventing end-users from replacing them with non-approved antennas. Antennas other than T24-ANTA, T24-ANTB, T24-ANTC, T24-ANTD, T24-ANTE and those listed below, must be tested to comply with FCC Section 15.203 (unique antenna connectors) and Section 15.247 (emissions).

Manufacturer Code	Description	Gain	Available From
DELTA7A	Dual band 2.4 or 5.8GHz Hinged mount whip	2.1dBi	Sequoia
DELTA14	Stubby WiFi / WLAN Antenna	2.0dBi	Sequoia
DELTA15/SMAM/RA/RP11	2.4GHz Right angle RPSMA	2.0dBi	Sequoia
1699481	AUREL ANT.RP SMA 2.4GHz	2.0dBi	Farnell Electronic Components
537-785	EAD, FBKR35068-RS-KR WiFi Antenna	2.0dBi	RS Components

Transmitter modules have been certified by the FCC for use with other products without any further certification (as per FCC section 2.1091). Changes or modifications not expressly approved by Mantracourt could void the user's authority to operate the equipment.

In order to fulfil the certification requirements, the OEM must comply with FCC regulations:

1. The system integrator must ensure that the text on the external label provided with this device is placed on the outside of the final product.
2. The transmitter modules with external antennas may be used only with Approved Antennas that have been tested by Mantracourt.

Appendix G - Worldwide Regional Approvals

<i>Region</i>	Product Conforms To
Europe	CE
USA	FCC
Canada	IC

Important Note

Mantracourt does not list the entire set of standards that must be met for each country. Mantracourt customers assume full responsibility for learning and meeting the required guidelines for each country in their distribution market.

For more information relating to European compliance of an OEM product incorporating the T24 or Broadweigh range of modules, contact Mantracourt, or refer to the following web site: **www.ero.dk**

EU DECLARATION OF CONFORMITY

We, the undersigned:

Name of Manufacturer:

Mantracourt Electronics Ltd

Address:

**The Drive, Farringdon, Exeter, Devon,
EX5 2JB**

Country:

United Kingdom

Declare under our sole responsibility that the **Broadweigh Product Range** is in conformity with the following relevant Union harmonisation legislation:

LVD Directive 2014/35/EU

EMC Directive 2014/30/EU

RoHS Directive 2011/65/EU

Radio Equipment Directive 2014/53/EU

Machinery Directive 2006/42/EC

Based on the following harmonised standards:

EN 61326-1:2013

EN 61326-2-3:2013

EN 61010-1:2010

EN 300328 V2.1.1

Name and position of person binding the manufacturer or authorised representative:

Signed

Name:

Robert Willmington-Badcock

Function:

Managing Director

Location:

Mantracourt Electronics Ltd

Date of issue:

2nd November 2018

FCC ID: VHARA24

IC:7224A-RA24



Warranty

All Broadweigh products from Mantracourt Electronics Ltd., ('Mantracourt') are warranted against defective material and workmanship for a period of one (1) year from the date of dispatch.

If the 'Mantracourt' product you purchase appears to have a defect in material or workmanship or fails during normal use within the period, please contact your Distributor, who will assist you in resolving the problem. If it is necessary to return the product to 'Mantracourt' please include a note stating name, company, address, phone number and a detailed description of the problem. Also, please indicate if it is a warranty repair.

The sender is responsible for shipping charges, freight insurance and proper packaging to prevent breakage in transit.

'Mantracourt' warranty does not apply to defects resulting from action of the buyer such as mishandling, improper interfacing, operation outside of design limits, improper repair or unauthorised modification.

No other warranties are expressed or implied. 'Mantracourt' specifically disclaims any implied warranties of merchantability or fitness for a specific purpose.

The remedies outlined above are the buyer's only remedies. 'Mantracourt' will not be liable for direct, indirect, special, incidental or consequential damages whether based on the contract, tort or other legal theory.

Any corrective maintenance required after the warranty period should be performed by 'Mantracourt' approved personnel only.



Document Title: **Broadweigh User Manual**
Applies To: **Broadweigh Product Range**
Part Number: **517-927**
Issue Number: **03.14**
Dated: **24th September 2025**

In the interests of continued product development, Mantracourt Electronics Limited reserves the right to alter product specifications without prior notice.



www.mantracourt.com